

SIRUBA

操作説明書

OPERATION MANUAL

■ PATTERN MACHINE TOUCH PANEL

The background is a solid gray color. In the lower half, there are two large white geometric shapes. One is a trapezoid on the left, and the other is a trapezoid on the right, both pointing towards each other, creating a central negative space.

ENGLISH

ENGLISH





GENERAL SAFETY INSTRUCTION







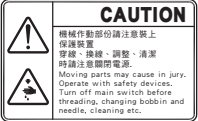



For the sewing machine, automatic mechanic system, and auxiliary devices (hereinafter referred as “machine”), it is inevitable to conduct work near moving parts of the machine. This means that there is always a potential risk from the moving parts. Operators actually operating the machine and service technicians performing maintenance and repair are strongly advised to read and understand fully the following instructions in advance.

The safety instructions include items which are not listed in the specifications of your product.

It is the manager/supervisor’s responsibility to have their fellow workers fully understand before operation. Fail to follow the instructions listed in this manual may cause severe injury or even death, and damage to the property.

Explanation of warning indications and labels.

 <p>高壓電危險 DANGER 注意: 修理前請關閉電源 TO OPEN THE COVER TURN OFF POWER SUPPLYING AND WAIT MORE THAN 10 MINUTES BEFORE WORKING.</p>	<p>CAUTION HIGH VOLTAGE</p> <p>Do not open the cover of control box within 10 minutes after turn off the power.</p>	 <p>Be careful of its movement. 移動快速 敬請小心</p>	<p>HIGH SPEED MOTION POSITION</p> <p>In case of industrial accident</p>
 <p>CAUTION 機械作動部份請注意 保護裝置 穿線、換線、調整、清潔 時請注意斷電。 Moving parts may cause injury. Operate with safety devices. Turn off main switch before threading, changing bobbin and needle, cleaning etc.</p>	<p>CAUTION HIGH SPEED MOVING PARTS</p> <p>PREVENT FROM WORK-RELATED INJURIES</p>		<p>HIGH SPEED MOTION POSITION</p> <p>In case of industrial accident</p>

PICTORIAL WARNING INDICATION		PICTORIAL WARNING INDICATION	
	<p>There is a risk of injury if contacting a moving section.</p>		<p>Be aware that holding the sewing machine during operation can hurt your hands.</p>
	<p>There is a risk of electrical shock if contacting a high-voltage section.</p>		<p>There is a risk of entanglement in the belt resulting in injury.</p>
	<p>There is a risk of a burn if contacting a high-temperature section.</p>		<p>There is a risk of injury if you touch the button carrier.</p>
	<p>Be aware that eye de ciency can be caused by looking directly at the laser beam.</p>	INDICATION LABEL	
	<p>There is a risk of contact between your head and the sewing machine.</p>		<p>The correct direction is indicated.</p>
			<p>Connection of a earth cable is indicated.</p>

SAFETY PRECAUTIONS

Danger

An accident means "to cause personal injury or death, or damage to property."

When it is necessary to perform service on electrical parts, be sure to turn the power off and wait for 5 minutes or more before opening the power cabinet/box in order to avoid electrical shock.

Caution

1. Basic precaution

- (1) Read the manual and other papers supplied with accessories of the machine before operation. Keep the manual and papers at hand for quick reference.
- (2) The content of this section includes items which are not listed in the specification of your product.
- (3) Always wear safety goggles and gloves to avoid accident caused by parts breakage.
- (4) For those who use a heart pacemaker, please consult the medical specialist first.

2. Safety devices and warning labels

- (1) Check to ensure all safety devices are correctly installed in place and properly before operation.
- (2) If any of the safety devices is removed for service cause, please be sure to replace it back to position and verify that it works normally before resuming operation.
- (3) Always keep the warning labels adhered on the machine clearly visible. If any of the labels is missing or contaminated, replace with a new one at soon.

3. Application and modification

- (1) It is prohibited to use the machine for any application other than its original intention, or in any manner other than that prescribed in the instruction manual.
- (2) Never modify or alter the machine. Any unauthorized change of the specification will not be covered by the warranty.
- (3) Our company assumes no responsibility/liability to damages, injuries, or death resulting from the machine which has been modified or altered.

4. Education and training

- (1) The plant managers/supervisors are obliged to provide education and training to operators and service technicians. A good education/training plan not only avoids personal injury but also prevent damage to the property.
- (2) Only a well-trained operator is allowed to operate the machine.
- (3) Only a certified technician is allowed to perform service to the machine.

5. Situations that you must turn off the power

Turning off the power: press EMG Stop (if there is one), switch off the power, and remove the power plug from the outlet.

- (1) When there is a failure or abnormality, press EMG Stop (if there is one), switch off the power.
- (2) To prevent accident resulting from abrupt start of the machine, before operating the machine, always turn off the power and switch on again.
- (3) When cleaning or inspecting the machine, make sure the machine stops completely after turning off the power.
- (4) When performing service (i.e. changing of adjusting any component), make sure the power is off and the machine stops completely.

6. Remove the power plug by holding the plug section instead of the cord to avoid electrical shock, leakage, or fire accident.
7. Turn off the power whenever the machine is left unattended between works.
8. In case of a power failure or black out, turn off the power to avoid damage or accident.
9. Fail to obey instructions above may cause severe injury or death to the operators.

PRECAUTIONS TO BE TAKEN IN VARIOUS OPERATION STAGES

1. Transportation

- (1) When you lift or move the machine, please take the machine weight into consideration and apply a safe manner. Refer to the specification for the information you need for transportation.
- (2) Apply sufficient safety measures when lifting or moving the machine to avoid falling or dropping.
- (3) To avoid unexpected accident, do not reuse the packing material for transportation.

2. Unpacking

- (1) Before proceeding to unpacking, check the balance of the machine and apply necessary tools to hold the proper position.
- (2) When unpacking, follow the instruction printed on the cartoon. Be careful of the nails and chips when unpacking from a wooden rack.

3. Installation:

3A. Table and Stand

- (1) Only adopt a qualified genuine table and stand to assure the holding support. In case you need to leave the machine on a surface temporarily for service, make sure the surface is strong enough to hold the weight.
- (2) If casters are applied to the table stand, adopt casters with a locking mechanism only and lock them well to secure the machine during the operation and service.

3B. Cable and Wire

- (1) The cables and wires must comply with the specification and requirement.
- (2) The cables and wires shall be free from bending or extra force. Reserve a free space of at least 30mm between cables/wires and the moving parts.
- (3) Do not apply starburst connection when wiring.
- (4) All connectors must be fixed securely. And always hold the connector body when removing it.

3C. Grounding

- (1) Grounding is necessary and must be done by a certified technician.
- (2) Check and ensure the grounding is secured before operation.

3D. Motor

- (1) The motor must comply with the specification and requirement.
- (2) If there is a belt in the motor transmission, adopt or apply a proper protector to avoid entangling.

4. Before Operation

- (1) Before turning on the power, make sure all the connectors, cables, and wires are free from damage, dropout, or looseness.

- (2) Check and make sure the pulley rotation follows the same direction as labels.
- (3) Make sure all the stand casters are locked or fixed in position.
- (4) Keep the working area clean from obstacles.

5. During Operation

- (1) Always keep your fingers, hair, or clothing away from the moving components and moving area. Do not place your personal belongings on the machine.
- (2) The machine is designed to run at high speed. Always keep your hands away from the moving area. Do not resume the work cycle until the machine stops completely.
- (3) Be careful not to be caught by the machine or components when removing or resetting the machine.
- (4) To avoid accident caused by abrupt start, when performing service on the motor or belt, make sure the power is off and the machine stops completely.
- (5) A servo motor is silent as the machine stops. Be sure to turn off the power to avoid an abrupt start.
- (6) Always keep the fan and airway of the power cabinet clean from any obstacle.

6. Lubrication

- (1) Apply only qualified oil and grease onto the parts as instructed in the manual.
- (2) If the lubricant contacts your eye or body, wash it off immediately. Consult a medical care if necessary.
- (3) If the lubricant goes into your body accidentally, go to the nearby medical care immediately.

7. Service

- (1) Only a certified engineer/technician is allowed to perform service to the machine, including adjusting and repairing. Use only genuine parts for replacement. Our company assumes no responsibility/liability for any accident caused by improper repair or adjustment, or the use of any parts other than genuine one.
- (2) Only a certified technician or authorized engineer is allowed to repair or maintenance the electric system.
- (3) When performing service to air-driven parts, like an air cylinder, first disconnect the air supply and expel the air completely to avoid abrupt start.
- (4) Check all screws and nut are fixed well after adjusting and replacement.
- (5) A periodical cleaning is necessary. Make sure the power is off and the machine stops completely before cleaning.
- (6) If the machine functions poorly or abnormally, stop the operation and turn off the power. Contact the authorized dealers or us to request for a technical service support.
- (7) When there is a fuse failure, turn off the power, find out the cause of the failure and apply solution to it, then replace with a new one with the same spec.
- (8) Periodically check and clean the fan airway and the cable/wiring.

8. Working Environment

- (1) The machine should be free from the affection of electro-magnetic wave.
- (2) The power supply should be in good and reliable condition, the fluctuation of rated voltage should be less than 10%.
- (3) Always check the air pressure and quality. Some extra device might be needed if the supply is not reliable.
- (4) The machine is designed to be used with ambient temperature $5^{\circ}\text{C} \sim 35^{\circ}\text{C}$, relative humidity 35%~85%.
- (5) To protect the electronic components and for safety cause, when there is a frost resulting from a dramatic temperature rise, disconnect the power and wait until it dry completely.
- (6) For safety cause, when there is a thundering or lightening, stop the operation and disconnect the power supply.
- (7) Do not use TV or radio nearby the machine as to avoid interference.
- (8) Apply necessary protection during operation. Follow applicable regulations set by local administration.
- (9) For disposal of packages, lubricant, and product, please follow the applicable regulations set by local administration.

CONTENT**PAGE**

SUMMARY DESCRIPTION	1
INSTRUCTION	5
QUICK (P) PATTERN OPERATION	22
COMBINATION © PATTERN OPERATION	25
PATTERN EDITING	30
INFORMATION FUNCTION	39
COMMUNICATION FUNCTION	40
MODE AND PARAMETER SETTING	45
APPENDIX 1 ERROR TABLE	57

SUMMARY DESCRIPTION

Overview

This series of industrial sewing machine computer control system, the spindle motor is driven by the world's advanced level of AC servo control technology, featuring large torque, high efficiency, stable speed and low noise. Diversified operation panel design can meet the requirements of different customers. The system adopts German structure design, which is convenient and quick to install and maintain. The system control software can be upgraded through remote communication, which is convenient for users to continuously improve product performance.

Technical Data Sheet

	Project	Model
		Flat seam stitch sewing machine (with large hook)
1	Stitch Type	Single Needle Lockstitch
2	Maximum Sewing Speed	2,700rpm
3	Sewing Size (X×Y)	GSM-1310G maximum: 130×100mm; GSM-2210G maximum: 220×100mm
4	Feeding Type	Intermittent Feed (Stepping Motor)
5	Needle Gauge	0.05-12.7mm
6	Total Stitch	Memory 500,000 stitch (※)
7	Maximum Stitch	20,000 stitches (1 program)
8	Storage of pattern data in the memory	Memory: 999 (※). USB: No Limit
9	Type of Pressor Foot	Electromagnetic specifications: Stepping Motor, Pneumatic specifications: Pneumatic Type
10	Lift length of clamp	Electromagnetic specifications: up to 25mm, Pneumatic specifications: up to 30mm
11	Two Step Pressor Foot	Electromagnetic specifications: left and right integrated presser foot. Pneumatic specifications: left and right split presser foot
12	Intermittent presser foot lift length	22mm
13	Intermittent presser stroke size	2-4.5mm、4.5-10mm 或 0 (3 mm at the factory)
14	Hook Type	Half turn 2x hook (standard hook optional)
15	Thread Fastening Device	Standard
16	Thread Trimmer Device	Standard
17	Data Storage Type	Memory (flash memory), CF card (32, 64, 128, 256MB) [Optional] 3.5 Disk 2HD/1.44MB.2DD
18	Number of User Program	50
19	Number of Loops	9
20	Motor	AC Servo Motor 550W
21	Total Weight	Machine Head: approximately 88kg, Operating Panel: approximately 0.6kg Control Box: 14.2-16.2kg (Depend on Voltage)
22	Voltage	Single phase 100V/220V, 3-phase 200V/220V/380V/400V 400VA
23	Air Consumption	0.5Mpa 1.81/min

Maximum sewing speed should be reduced according to the sewing conditions.

Safety Precautions

1. Operating environment

Do not use this control unit in the following environments:

(1) Power supply voltage

Voltage fluctuation will exceed $\pm 10\%$ of the rated voltage.

Power supply capacity cannot be guaranteed in a location with a specified capacity.

(2) Radio interference

Nearby location with radio wave transmitters, high-frequency machines generate strong electric and magnetic fields.

(3) Temperature and Humidity

Room temperature is between 0°C to 50°C .

Outdoor or direct sunlight.

Location next to heater

Relative humidity is between 5% and 95% (non-condensing).

(4) Air

Corrosive or dusty location.

Place where air or oil explosion are likely to occur.

(5) Vibrate

Place where vibration most likely to occur. Control Box should be placed somewhere else without any vibration.

2. Assemble

(1) Control Box

Please follow instruction and install correctly.

(2) Attachment

To install other accessories, turn off the power and unplug the power cord.

(3) Power Cord

Do not use force to pinch the power cord or excessively twist the power cord.

Please do not leave the power cord near the rotating parts, at least 25mm or more.

Before the control box connects to power supply, please check whether the power supply voltage is same as voltage indicate on the control box and exact position. If a power transformer is used, the same power supply must be checked before it can be supplied. At this moment, power switch on the sewing machine should be at [OFF] position.

(4) Ground Wire

In order to prevent electric shock and electric leakage result electric shock. Grounding wire on the power line must be grounded.

(5) Accessories

If you need to use electrical accessories, please follow the instructions.

(6) Disassemble

Before remove control box, please turn of the power and unplug all power plugs.

While unplug power plug, please do not pull the wire.

Please pull the power plug by hands.

High voltage inside control box. Switch off power and wait for 5 minutes before open control box cover.

3. Maintenance, Inspection and Repair

Repair and maintenance task should be performed by trained technicians.

When replacing the needle and the bobbing, be sure to turn off the power.

Please use original parts from supplier

4. Other Safety Issue

Please do not touch any rotate and moving parts while sewing machine is running. (especially needle and belt accessories). Hair should not go near the machine to avoid any unexpected issue.

The control device must not fall to the ground, and it is not allowed to insert other items into the gap.

Please do not operate with the covers removed.

If the control device is damaged or cannot be operate. Please have it checked by an experienced technician or send to repair center. Please do not operate the machine until defects eliminated.

Please do not modify or change the control unit by yourself.



5. Disposal

Please dispose with general industrial waste.





6. Warning signs and danger signs

Wrongful behavior may result dangerous.

Please check below description

	Caveat: Wrong actions can result in serious injury or death.
	Note: Wrong actions can result in injury or damage to the house or property.

Symbol with description as below

	Please follow the instructions to work.
	Pay attention to the danger of high voltage.
	Pay attention to high temperatures.
	Be sure to connect the ground wire.
	Never do it.



Warning! Use of Precautions

1. Foot must leave the pedal before pressing [ON]



2. Power must turn off when operator left workstation.

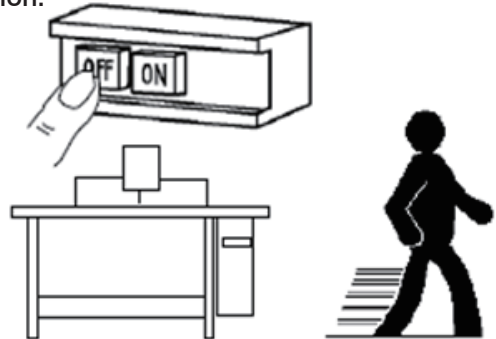

3. If you want to cross the head or change the needle or thread, be sure to turn off the power.

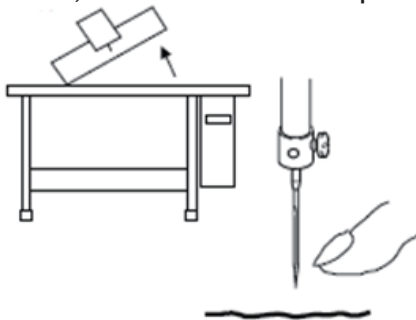

4. The grounding wire should be grounded.

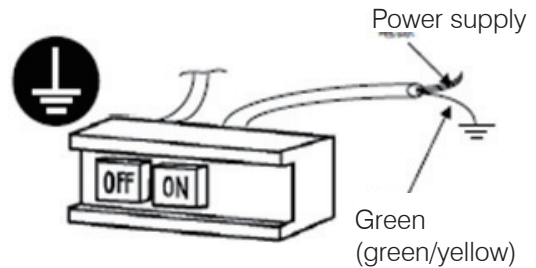

5. Do not use multi-jack extension cords for home use.

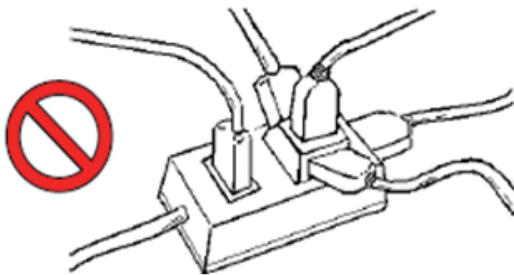

6. High voltage inside control box. Switch off power and wait for 5 minutes before open control box cover.

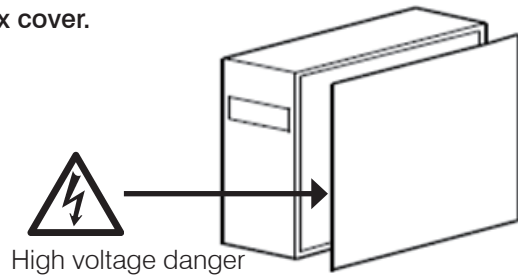

7. After replacing the motor, be sure to set the spindle motor mounting angle as shown in this document.

8. Keep away from machines that generate high-frequency interference.

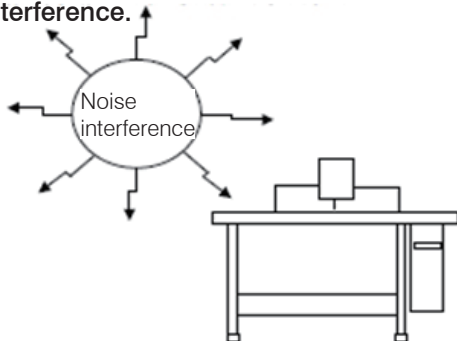

9. If the external signal socket is used to connect the application accessory, the length of the cable should be as short as possible. Long cable may cause malfunction. Use the isolation cable for the connection cable.

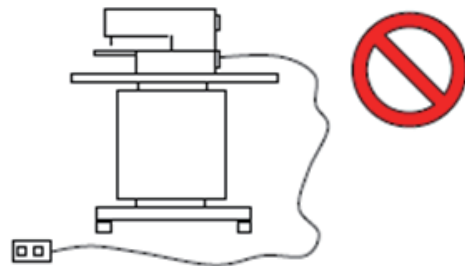

10. If the fuse is blown, please replace the issue and then replace the fuse with same capacity.

Standardization

Function buttons adopt industry-recognized graphic logo. Graphics are international languages that can be recognized by worldwide users.

Operation Method

screen operation panel system adopts the industry's advanced touch operation technology. It comes with friendly interface and convenient operation. Innovative changes to the daily use of the user. The user can use the finger or other object to touch the screen to complete the corresponding operation. Users should avoid touching the screen with sharp objects during operation to avoid permanent damage to the touch screen.

Function keys include a preparation key, an information key, a mode key, and a communication key. Refer to the descriptions in the following sections for specific operation methods.

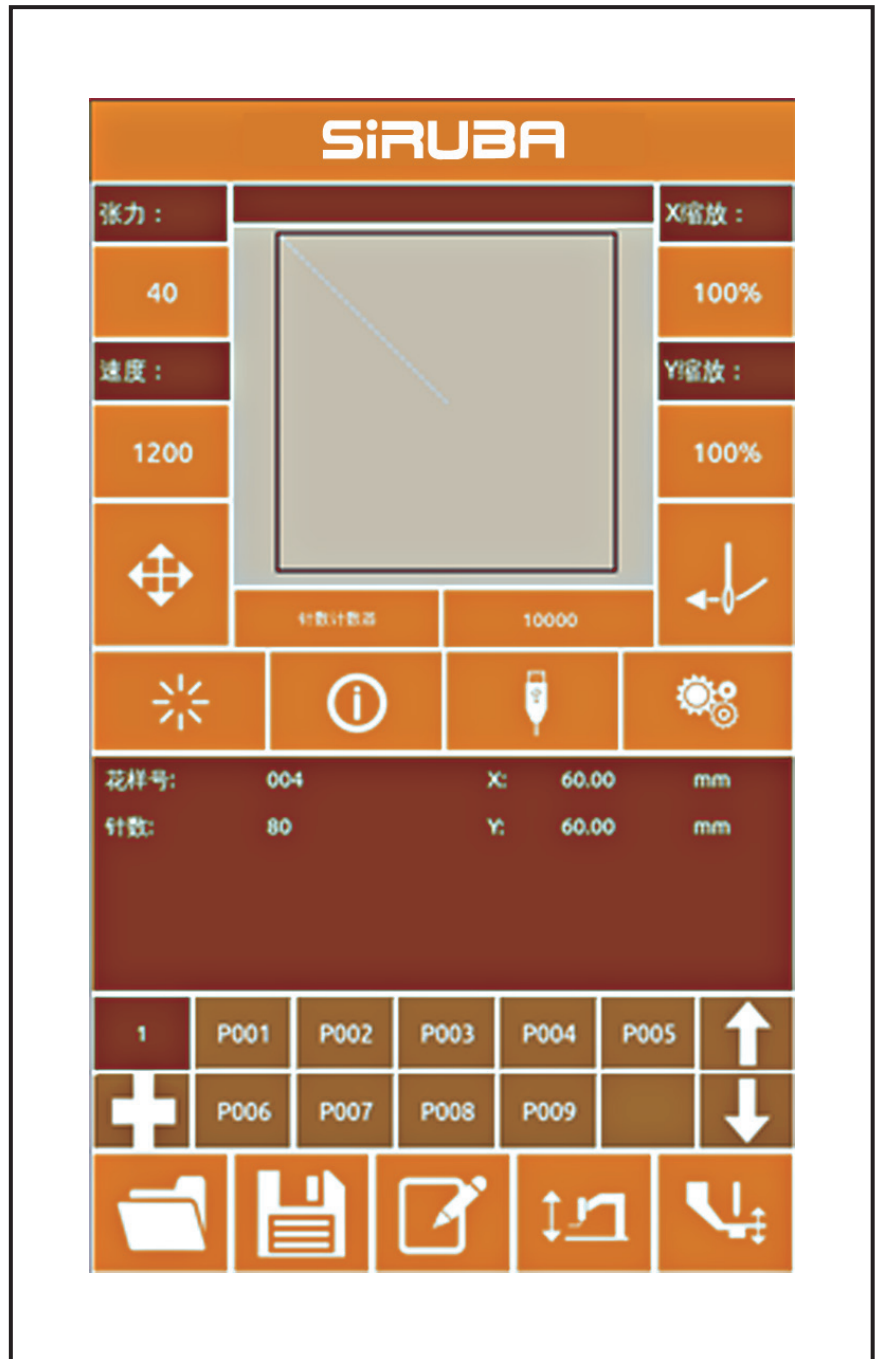

Warning! Users should take care to avoid touching the screen with sharp objects during use to avoid permanent damage to the touch screen.

INSTRUCTION

Universal Button

The buttons for common operations on each interface of the system are as follows:

No.	圖示	功能
1		Confirmation key → Input interface enters the sewing interface / sewing interface to exit to the input interface
2		Information button → View version information and threading diagram
3		Communication key → USB disk communicates with the panel to perform mutual copying of patterns or parameters
4		Setting button → Enter function interface
5		Pattern selection button → Open pattern file
6		Registration button → Register pattern number
7		Name key → enter the name of the pattern
8		Electric pressure frame lifting button → Motor type lift frame, pneumatic invalid
9		Medium presser foot height → Set height of intermediate presser foot
10		Adjustment button → Adjust the seam point
11		Threading key → Threading
12		Cancel button → cancel current set value / exit current interface
13		Confirmation key → Save current setting value
14		Trial sewing button → Enter single step seam interface
15		Winding button → enter winding mode

Basic Operatoin

① Turn On Power Switch



After the power is turned on, the data login interface is displayed.

② Select the pattern no.

The selected pattern No. will be displayed under the current interface. Press the pattern selection button  and enter the sub-menu to select the pattern No.

For details on the operation of pattern selection, see [2.8 Pattern Selection].

③ Prepare Mode for sewing

After pressing the READY key , the button is darkened  to indicate that the pattern confirmation interface has been entered. At this moment sewing can be performed.

④ Start Sewing

Place the sewing item on the presser foot, step on the pedal to lower the presser foot, start the sewing machine, and start sewing.

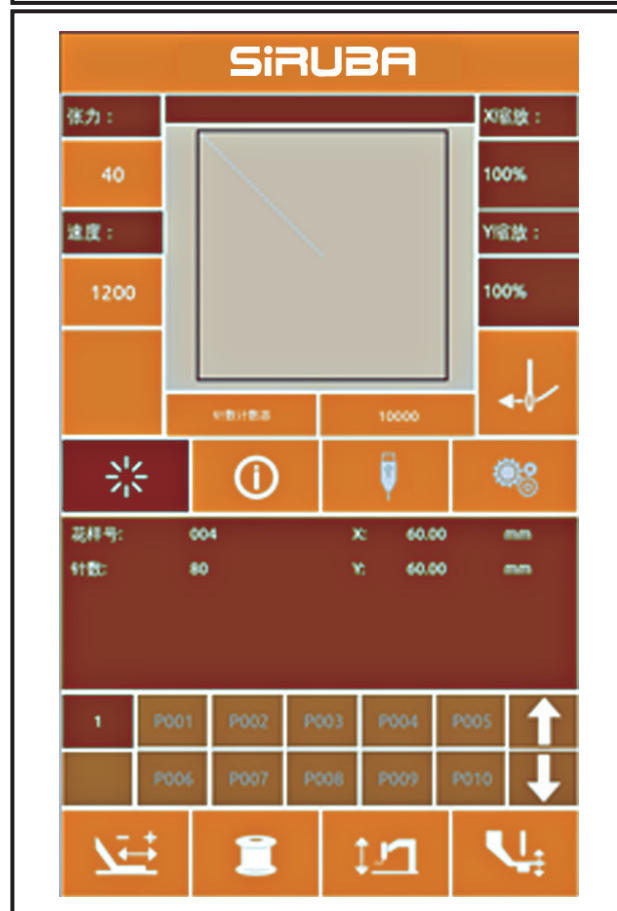
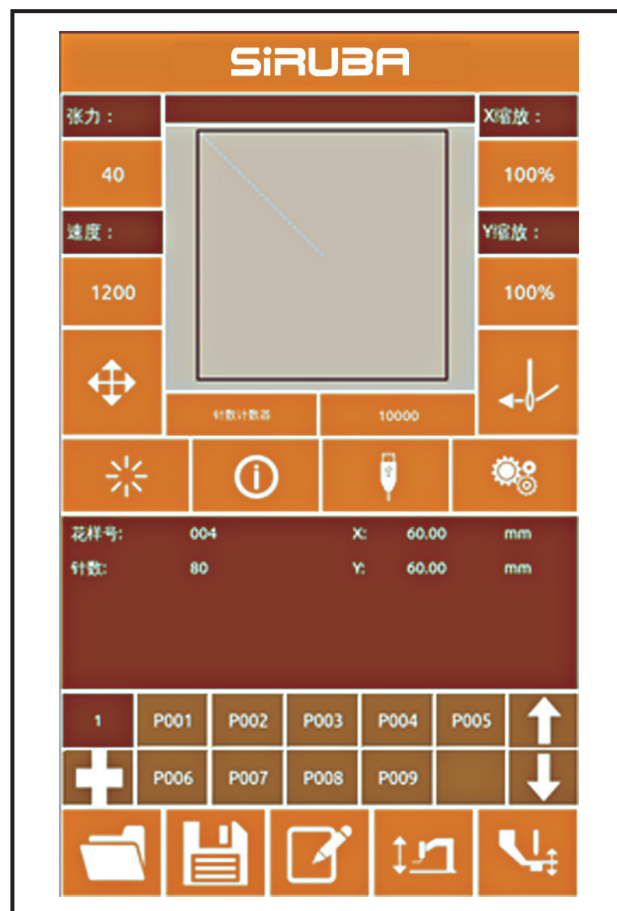

Ordinary Pattern Operation

(1) Sewing data registration interface

The data login interface as shown on right. For detailed function description, please refer to the function key description table.

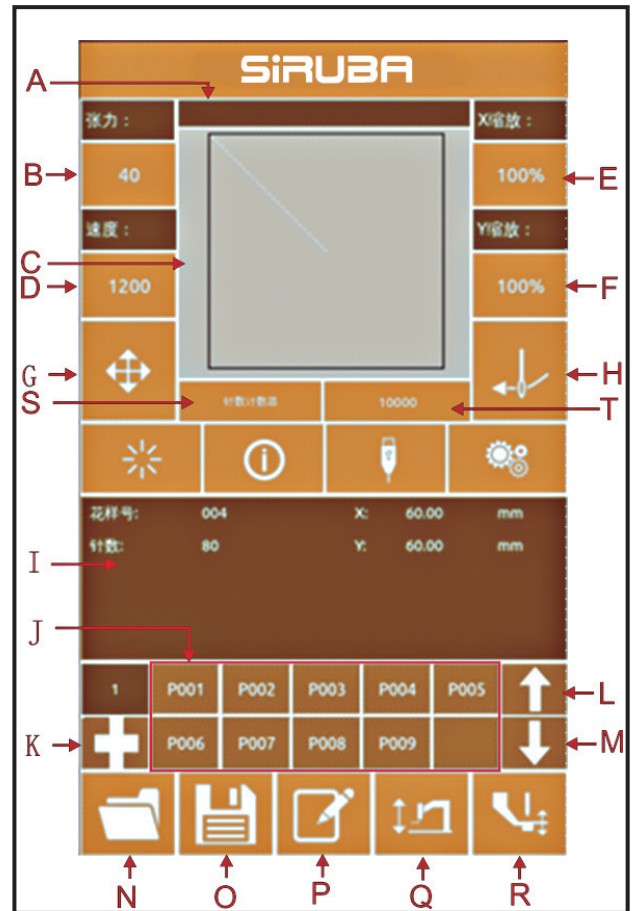

Function Description:

No.	Function
A	Pattern Name Display Area
B	Tension Button
C	Pattern Graphic Display Area
D	Speed Button
E	X Zoom Rate Button
F	Y Zoom Rate Button
G	Adjust the sewing point button
H	Threading Button
I	Pattern Information Display Area
J	P Pattern Shortcut Button Area
K	P Pattern Register Button
L	P Pattern Page up Button
M	P Pattern Page Down Button
N	Pattern Selection Button
O	Pattern Registration Button
P	Pattern Naming Button
Q	Electric Presser Foot Lift Button
R	Medium Presser Foot Height Button
S	Counter Mode Button
T	Counting Value Button

(2)Sewing Interface

Press  Ente to sewing interface as shown on the right. For detailed function descriptions, please refer to the function key description table.

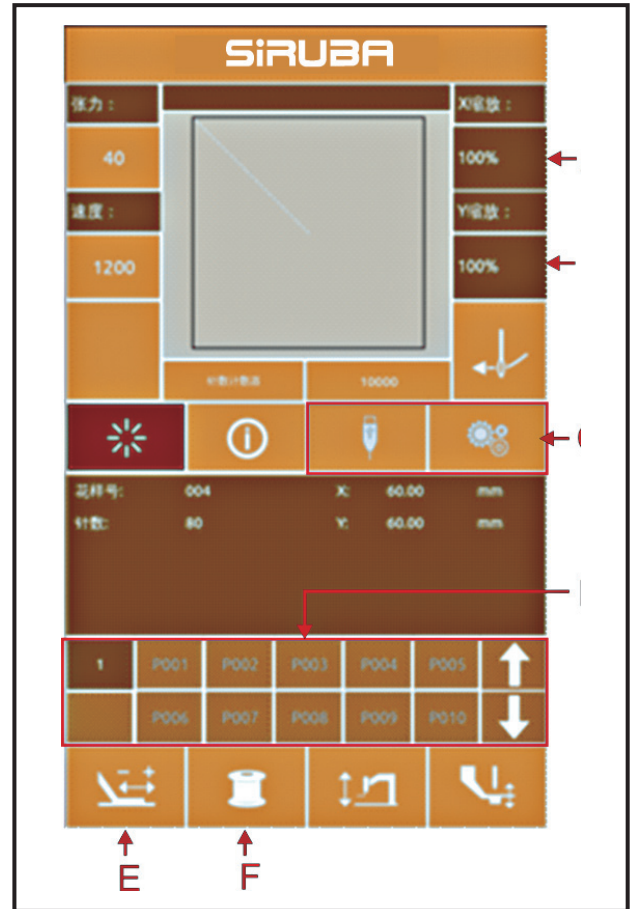

NO.	Function
A	X Zoom Rate Display
B	Y Zoom Rate Display
C	Inoperable Button
D	P pattern area is not operational
E	Trial Sewing Button
F	Winding Button
---	Other buttons with the input interface function

Pattern Registration

Up to 999 ordinary patterns can be registered.

Press  to enter the pattern registration interface (as shown on the right):

① Enter pattern number

Select desire pattern number by using the digit keys. The pattern number range must be 201~999. If you enter another number range will be displayed.

② Register New Pattern

After confirm the pattern number and pressing , previously displayed pattern data will be copied to the new registration pattern. And after the operation is completed, return to the new registration pattern data login interface.

If the entered number is already registered, it will overwrite existing pattern.

Press  the button to exit the registration interface.

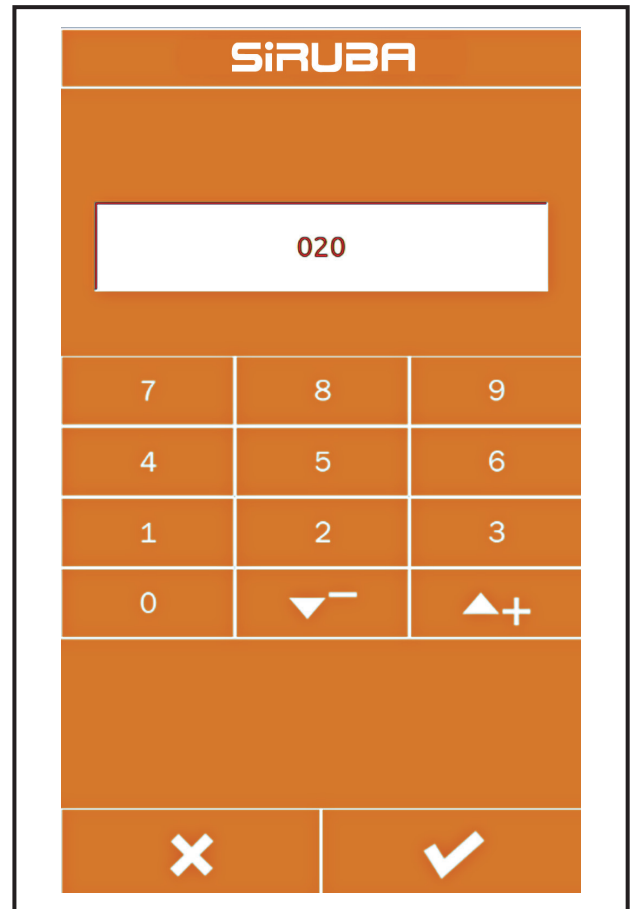

Pattern Naming

Press  to enter the pattern naming interface (as shown on the right)

A	Delete	Delete input characters one by one
B	Shift Right	Shift Right
C	Shift Left	Shift Left
D	Empty	Clear all characters currently entered

Select the character you want to enter and

press  to end the pattern naming operation.

Position of the character can be determined by

moving the cursor, and the delete key can eliminate

the position character.

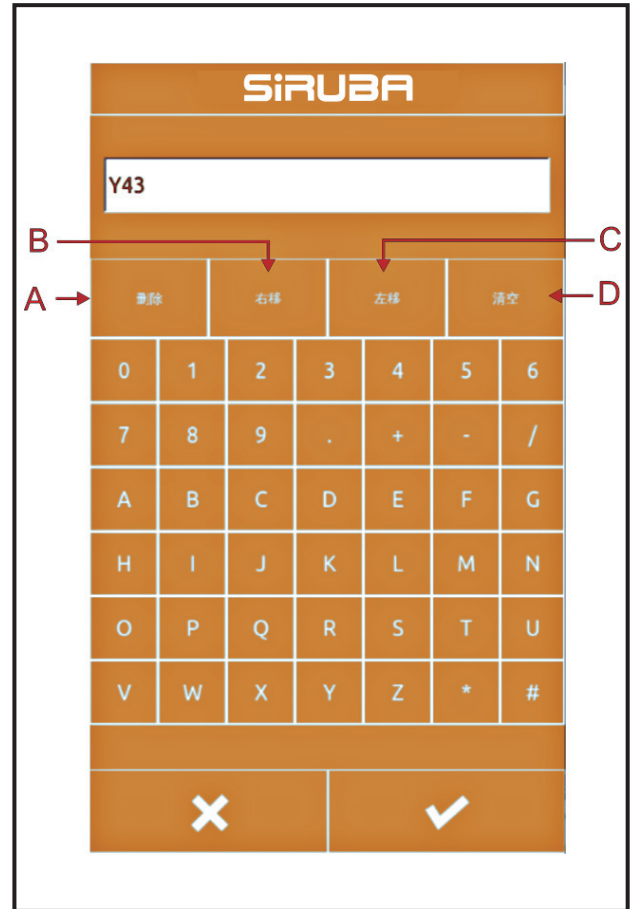

Winding

① Install Bobbin

Insert the bobbin as shown on the right.

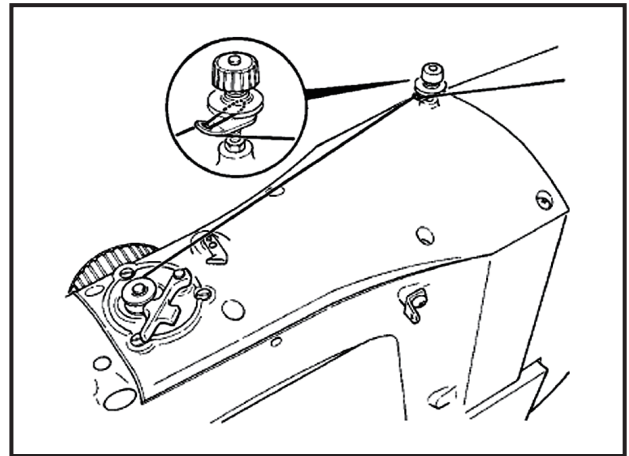

② Display bottom line winding interface

After the winding button is pressed  , the winding interface displayed (as shown on the right)

③ Start Winding

After stepping left pedal and presser foot drop, step on the start pedal to start winding.

④ Stop Sewing Machine

After the winding is started, step on starting pedal to stop rotating. Once winding stopped, step on the left pedal to lift the presser foot back to sewing mode.

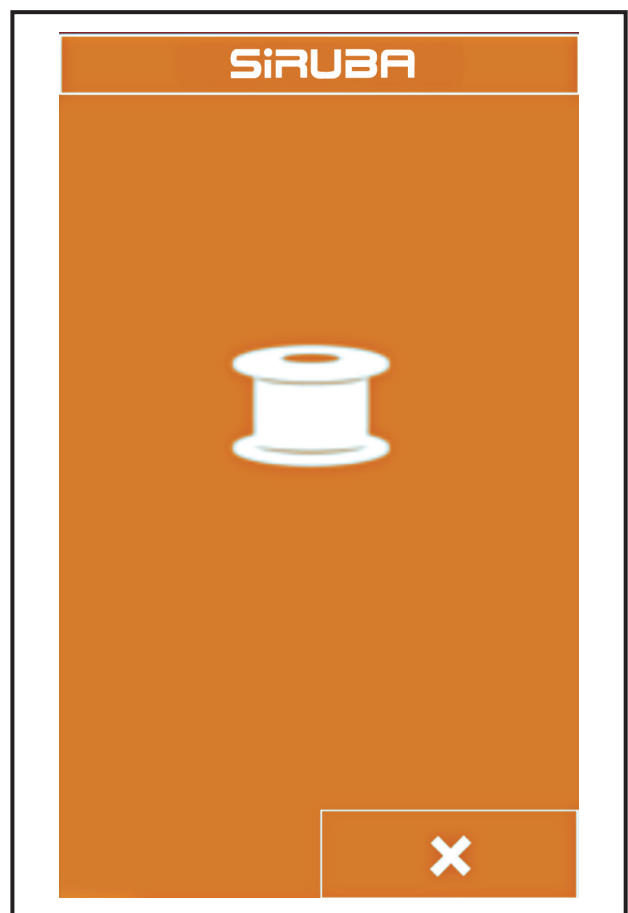

Threading

① Enter Threading Mode

Press the key on the input interface  or the sewing interface to enter the threading state. The

threading button turns red . The screen changes as shown in the figure. In this state, the machine cannot perform other operations.

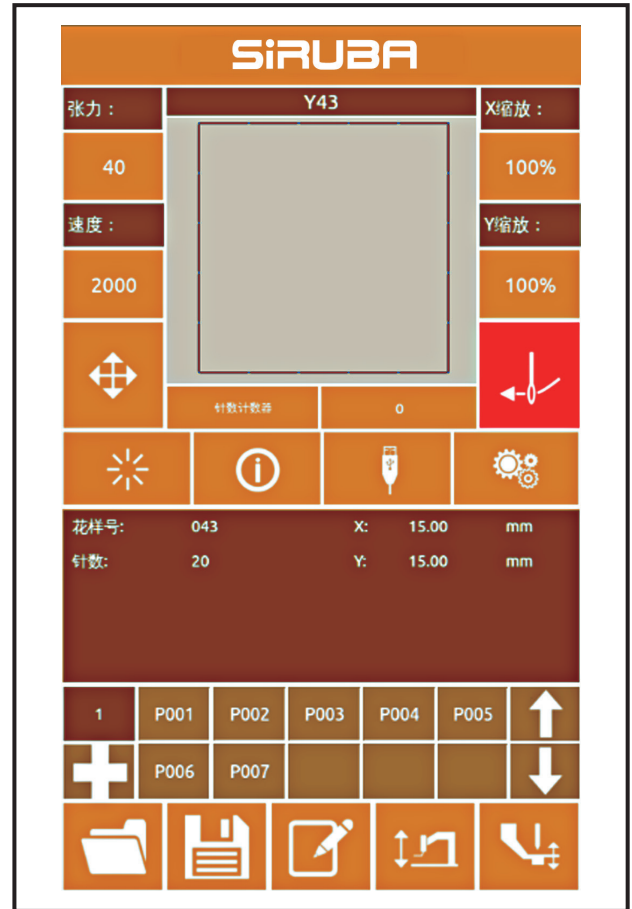

② Exit Threading Mode



After threading, press the key  again return back to input interface or sewing interface.

Pattern Selection

① Enter Pattern Selection Interface

Data registration interface (as shown in Figure 1 on the right), click on the selection button A to enter the pattern selection interface (Figure 2).

Figure 2 information as follows:

A	Pattern Name
B	Pattern Size Information
C	Pattern Display
D	Registered Patter Number
	Page Up
	Page Down
	Patter Delete

② Select Patter

Pattern number area D can display 25 pattern numbers per page; when a pattern number button is selected, the current pattern and information are displayed at the top.

Pattern information includes the pattern number, the length in the X direction, the height in the Y direction, and the string named by the pattern (Unnamed pattern does not display the string).

Press  to complete the pattern selection operation.

③ Pattern delete

Select a pattern number button and press  the button to delete the pattern.

Note: The pattern is divided into the basic pattern and the common pattern: the basic pattern is the factory pattern; the ordinary pattern is the pattern that the user prints, copies or imports from the U disk, the pattern can be deleted and modified, but the deleted pattern cannot be retrieved. Please be cautious.

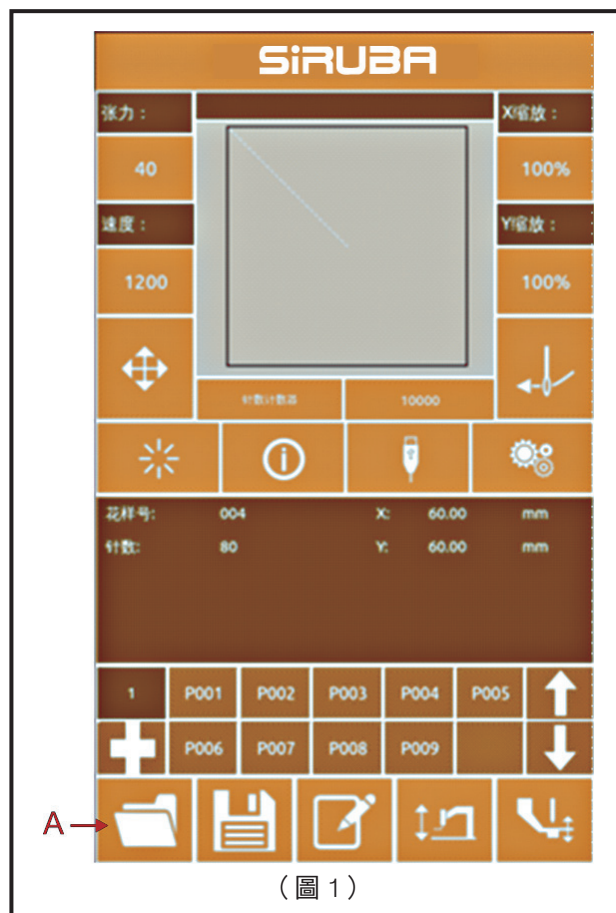

(圖 1)

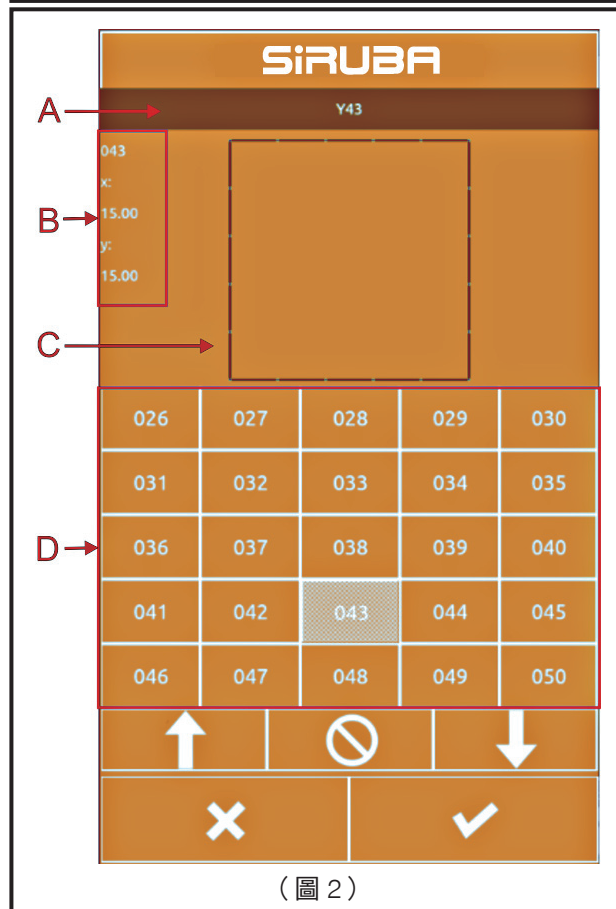

(圖 2)

Sewing Data Setting

① Enter sewing data setting interface

Press A, B, and C in the data login interface to enter the zoom ratio setting and speed limit setting interface respectively.

	Category	Input Range	Initial Value
A	Tension	0~120	40
B	Sewing Speed	400~2500rpm (the upper limit is set in the super setting parameter)	2000rpm
C	X direction zoom ratio	1.0~400.0%	100.0%
D	Y direction zoom ratio	1.0~400.0%	100.0%
E	Medium presser foot height	0.0~7.0mm	2.0mm

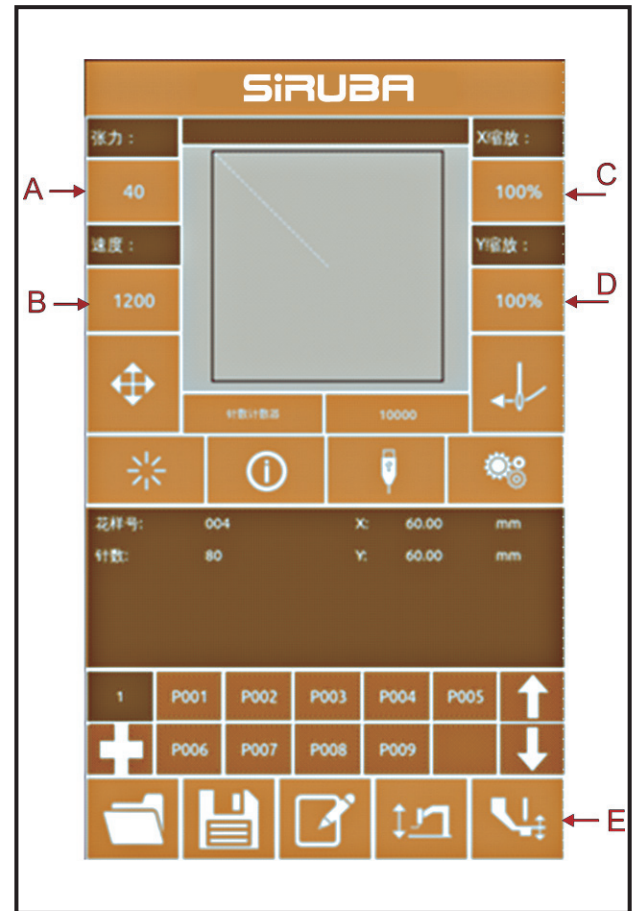

Note: Maximum speed limit is in "Super Settings

→ Parameters

② Zoom Rate Adjust

Zoom rate adjust interface as right picture.

Upper interface for X-axis, lower interface for Y-axis

A : X-direction zoom rate

B : X-direction actual length value

C : Y-direction zoom rate

D : Y-direction actual length value

Press “+” or “-” for designated value. After

entering value it will display at first digit. Previous

value will be automatic continue. Press  to complete adjustment and return back to Data

Register Interface

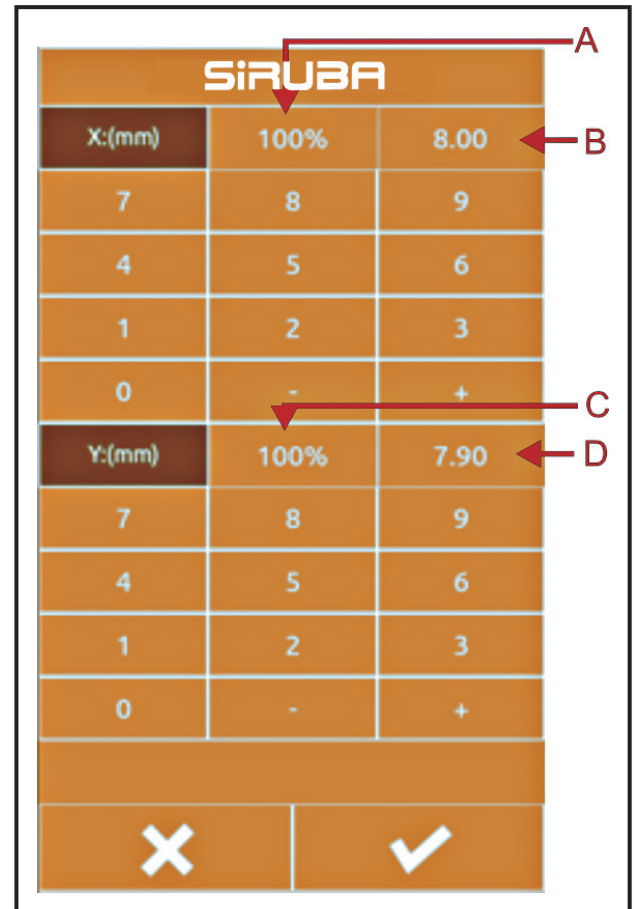

③ Speed Value Setting

Setting same as above

④ Middle Presser Foot Height Value Setting

Setting same as above

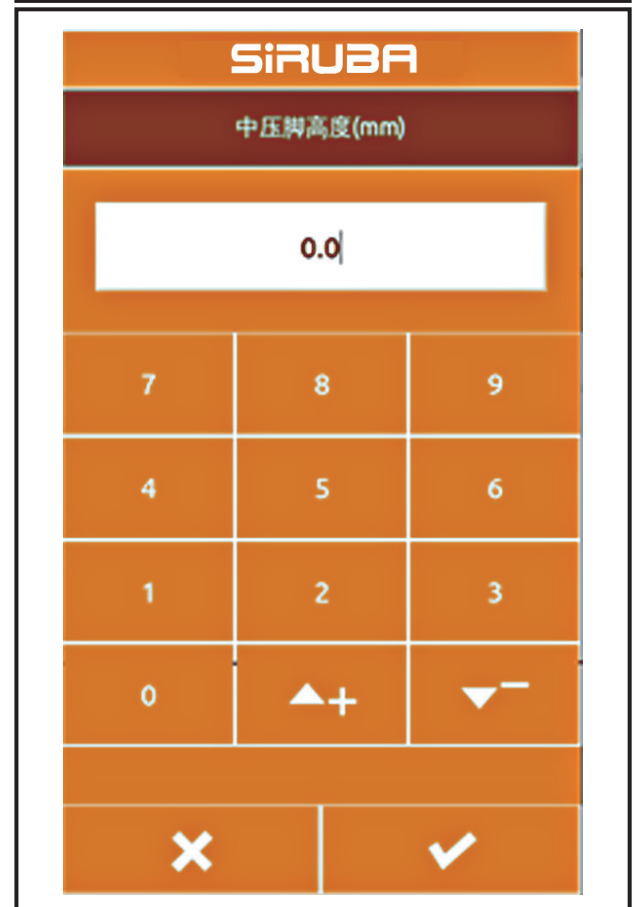





P Pattern Register

① Enter P Pattern Register Interface

Under Data Register Interface, press  to enter P pattern register interface as right picture.

② Enter P Pattern Number

By entering  ~  10 digit number keypad or  、  to enter designated register number. If values already enter, user may need to enter alternative number.

③ Select File Number

P pattern number can save up to 26 files. Each file can save 10 P pattern. Press button “A” to select file in orders.

④ Enter Patter Number

Enter confirm button  to finish P pattern register setting. After finishing will lead to P pattern register interface

⑤ Delete Pattern

Select P pattern number and press delete button  . Current P pattern will be deleted.

⑥ Check Registered P Pattern

Press below two button to check registered P pattern. User may register up to 255 P pattern



: P pattern page up



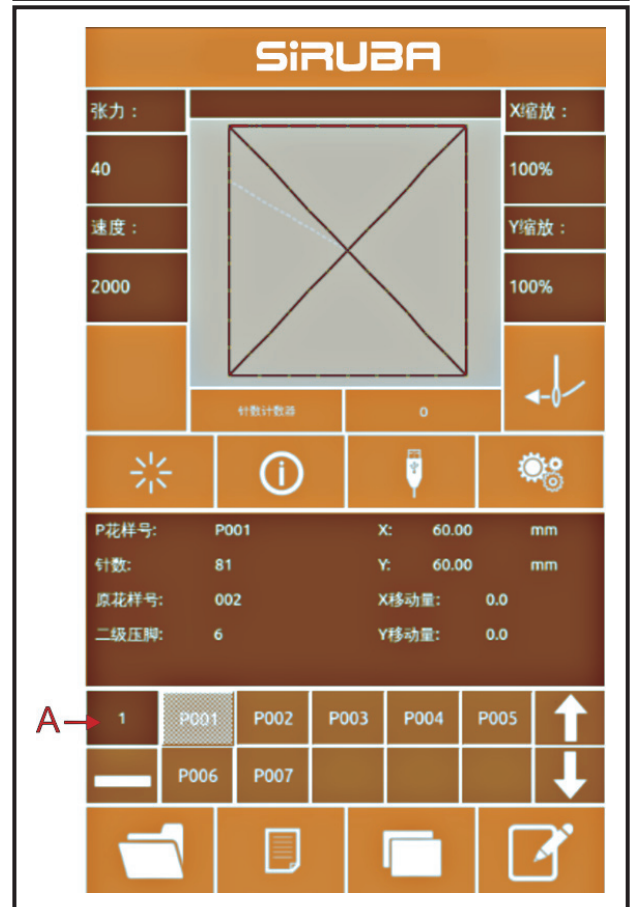
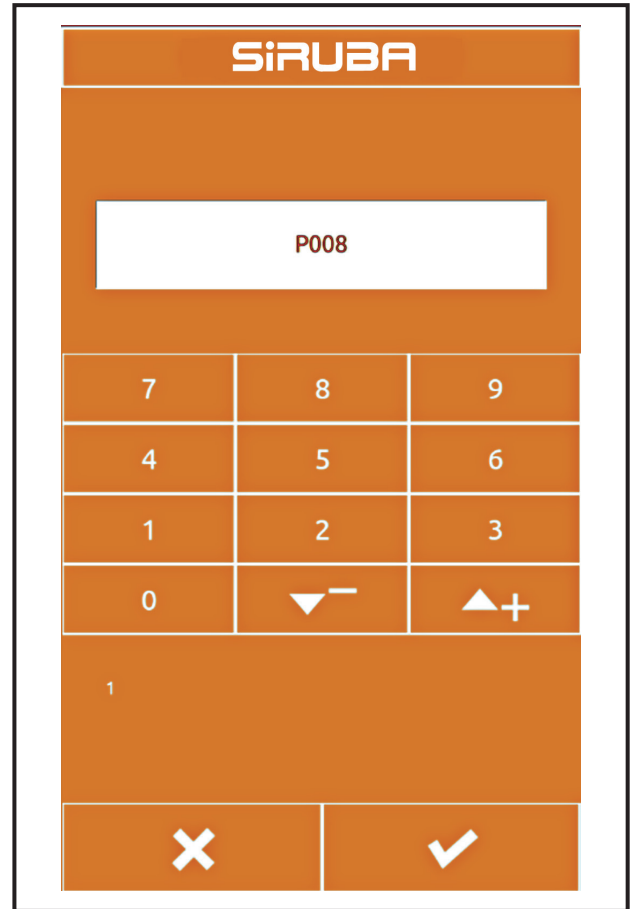

: P pattern page down









Trial Sewing Setting

① Display Sewing Interface

Under Data Register Interface, press “prepare button”  then prepare button will change to  mode. It means entered sewing interface.



② Display Trial Sewing Interface

Sewing interface icon as below. Press to enter sewing interface as right picture :

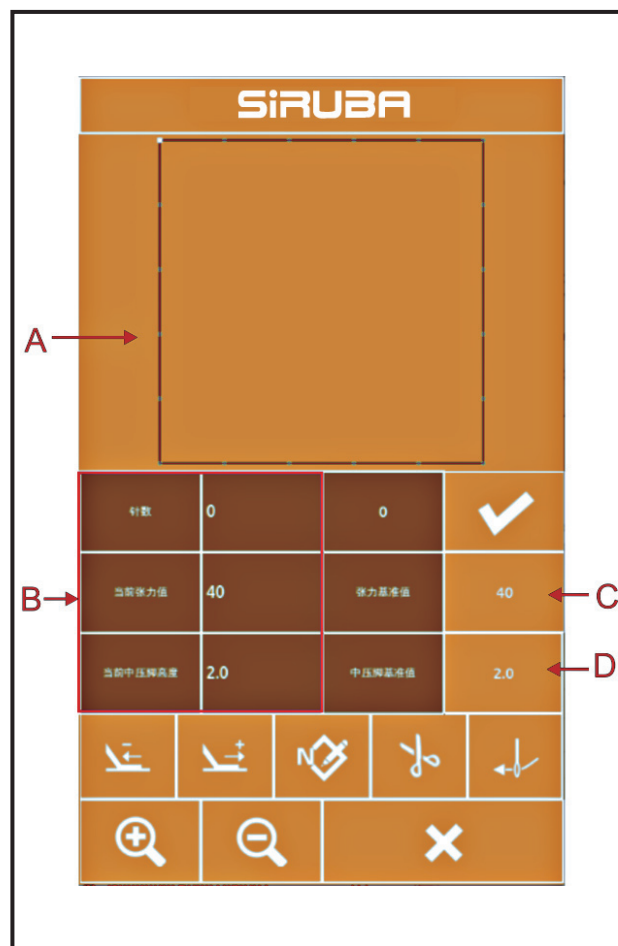
A	Pattern display area
B	Pattern information display area
C	Tension value setting button
D	Middle presser foot setting value button
	Single needle backward button
	Single needle forward button
	N needle moving button
	Trimmer button
	Threading button
	Pattern zoom in
	Pattern zoom out



③ Start Test Sewing

Enter trial sewing interface then presser foot will be lower down. Use presser foot backward button  and presser foot forward button  to confirm pattern.

④ Trial Sewing Interface

In the trial joint interface, the start pedal can be stepped directly at any position, and the machine will start sewing from the current position and return to the sewing interface.

⑤ Finish Trial Sewing

Press cancel button  to quit trial sewing interface then back to sewing interface. And also back to pattern sewing starting position.

Counter Setting

① Counter Interface

Enter interface or sewing interface as point A and B on right picture.

A	Counter Mode Button	1 : Stitch Counter 2 : Needle Counter
B	Counter Value Button	1 : Piece Counter 2 : Stitch Counter

User can press “A” counter mode button for quick switch to needle counter/ stitch counter” .
Button “B” for piece counter/ stitch counter.

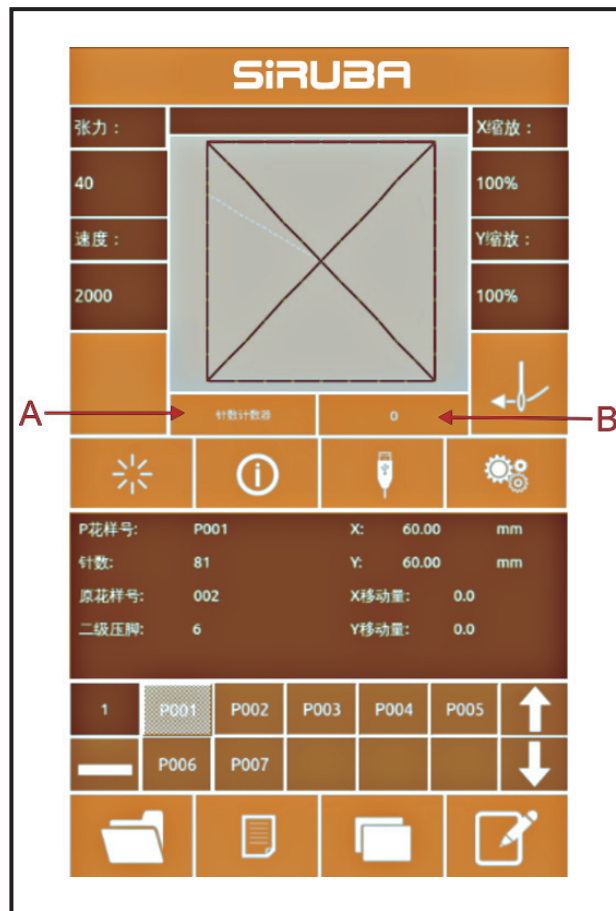

② Counter Return “0” Setting

Press button “B” for recount interface as shown in the figure.

Press button “C” to clear counter value and return to previous interface/ sewing interface.

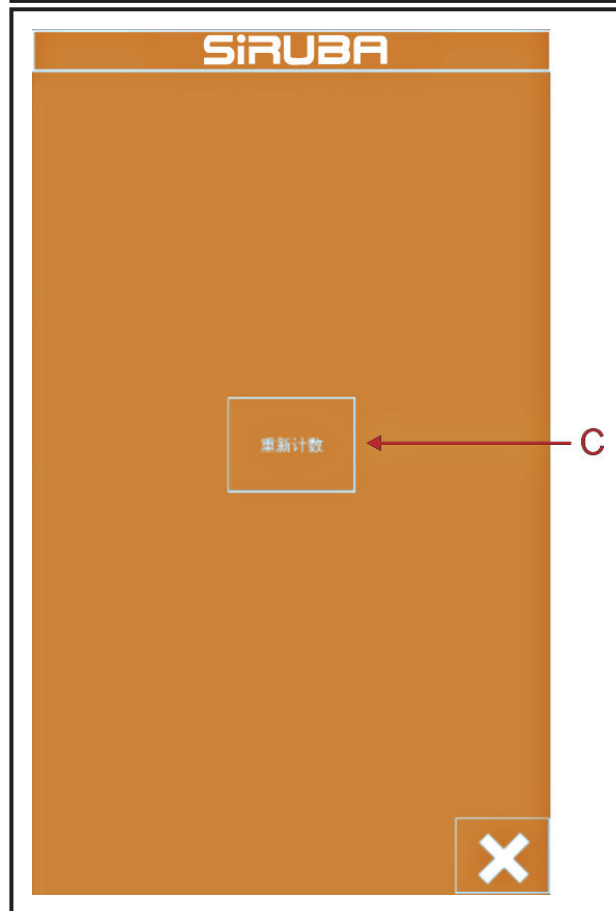

③ Needle Counter Setting

Press “D” button in setting to enter needle counter setting interface

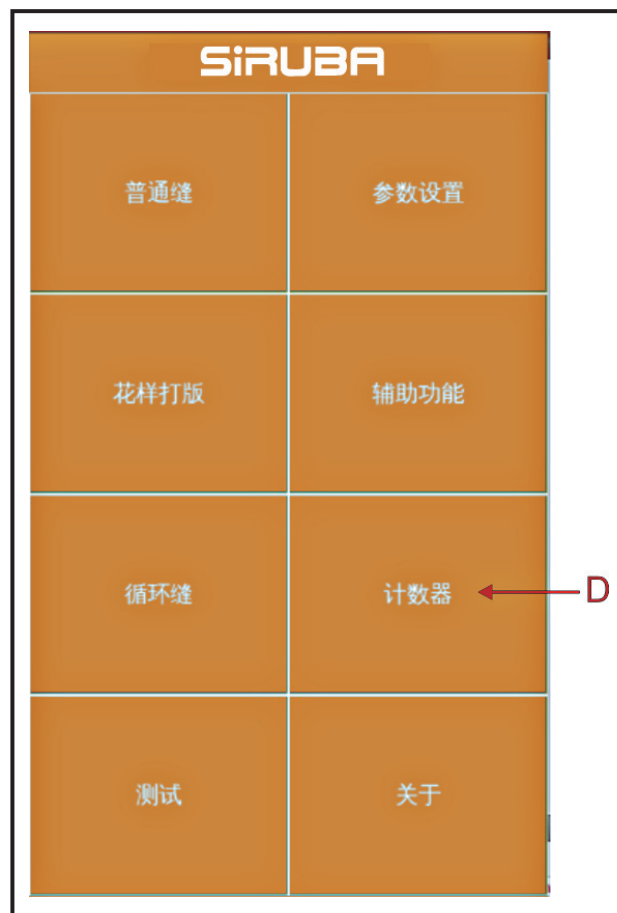

E	Stitch Counter Mode
F	Current Pieces Value
G	Stitch Counter Maximum Value
H	Needle Counter Mode
I	Current Needle Value
J	Needle Counter Maximum Value

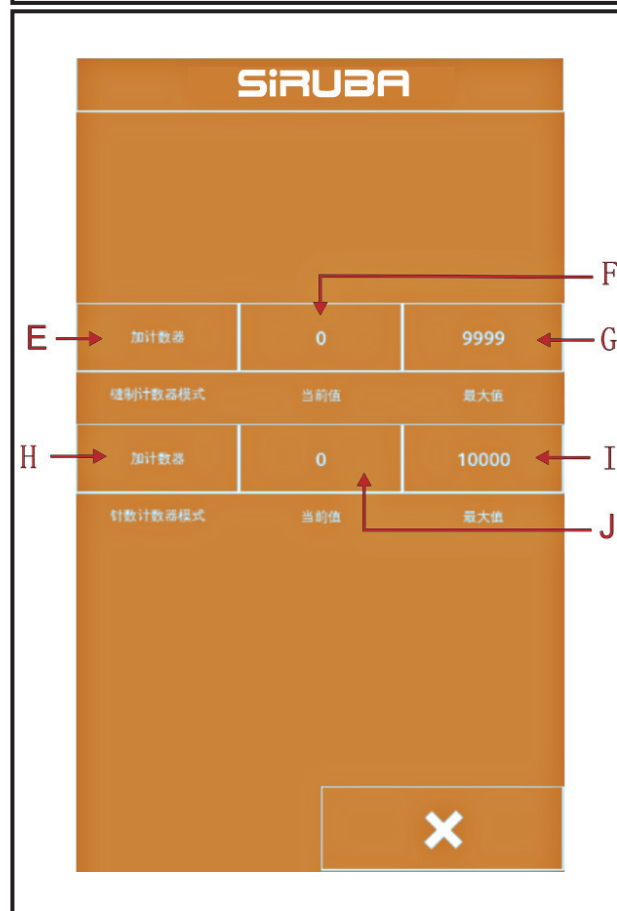



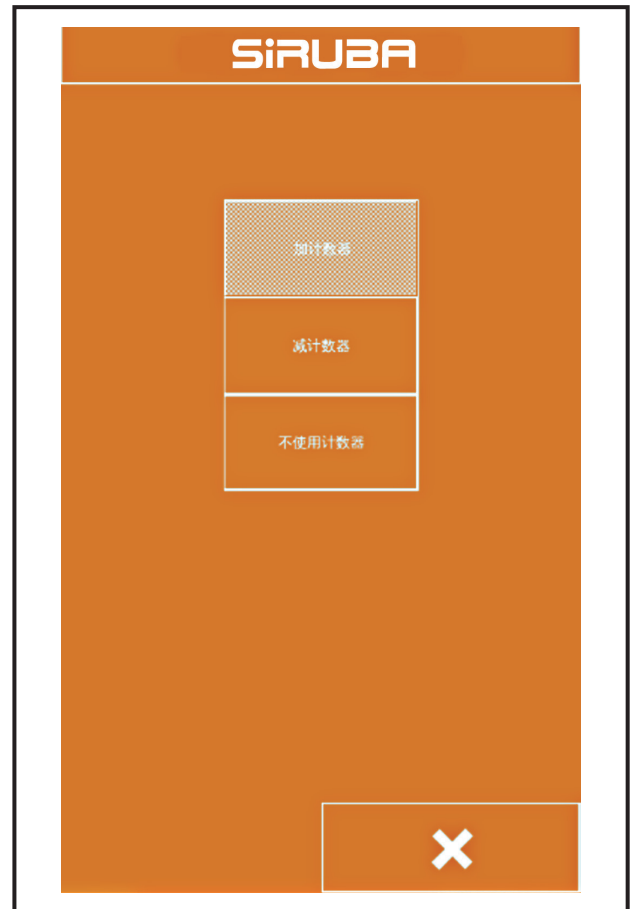

1. Set Counter Type

Press “E” or “H” to enter counter mode setting interface. Mode can be set as “add counter/ fewer counters/ no counter. After the mode is completed, press  to return previous interface.



2. Set Needle Count Value

Press F/J or G/I to set current needle count value and maximum needle count value. Enter the value using  ~  ten-digit keyboard or  、  to enter value.

Note: Maximum value for sewing counter is 9999 pieces, and maximum needle value is 65000.

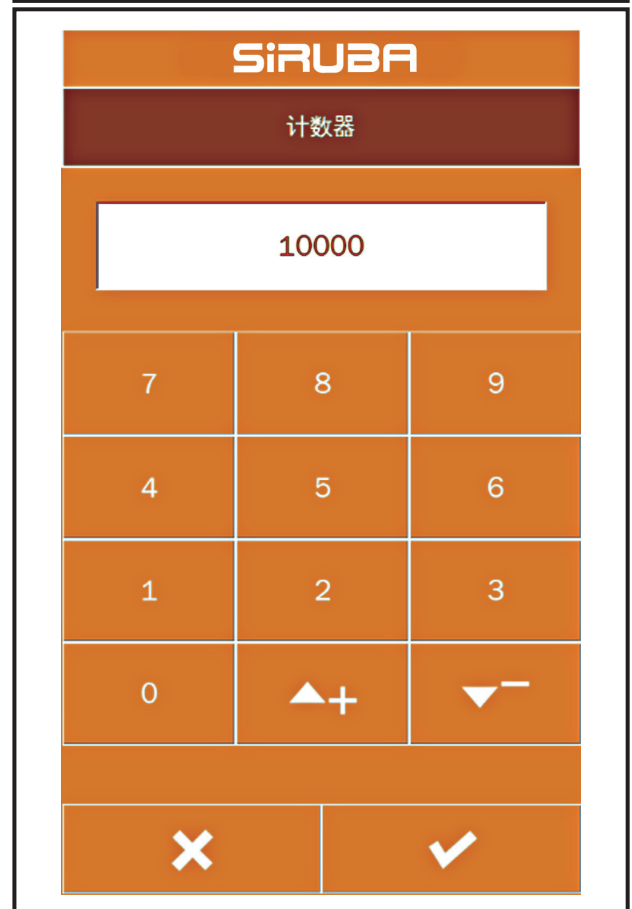

Adjust Seaming Point Operation

① Enter adjust Seaming Point Interface

In data registration interface press  to enter adjust seaming point interface as shown on the right figure.

A	Simulate stitching backward button
B	Simulate stitching forward button
C	Current needle position
D	One time moving needle button
E	Adjust data display
F	Display drawing area
G	Adjust stitch starting point button
H	Lift middle presser foot button

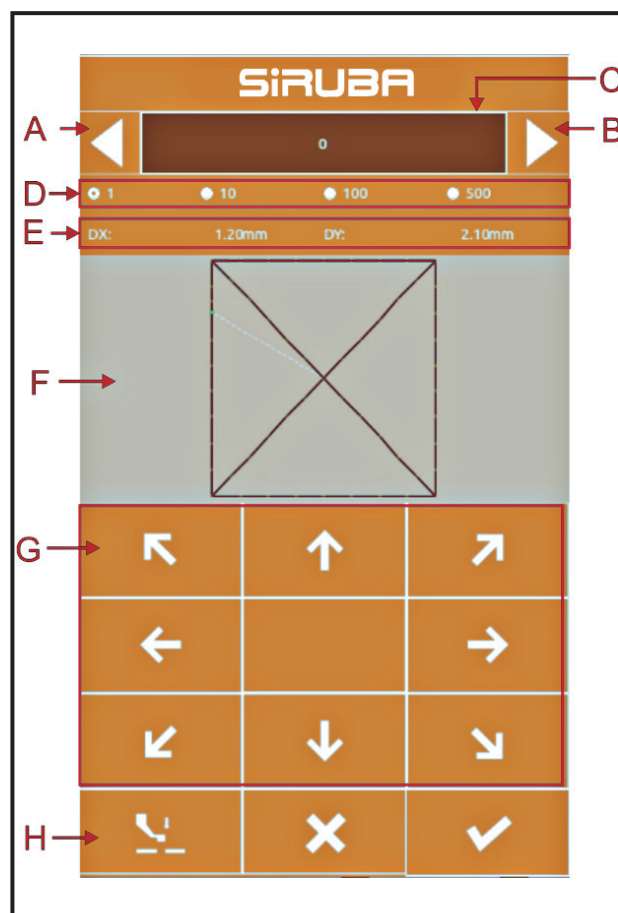

② Adjust Start Stitching Point

Press G area moving keyboard to move start stitching point. It will set as template for starting point. After finish seaming point press “A” “B” analog button to check whether it is aligned.

Simulation will move one stitch at a time. It may select “D” area button to move either 10 stitches, 100 stitches, or 500 stitches at a time.

Note: Starting stitch aligned standard based on...sewing path does not have deviation between needle and pattern. If there is a deviation, adjustment will still need to be continued. Press  to confirm adjustment.

③ Finish Trial Sewing

Press cancel button  return back to entering interface from setting interface.

Emergency Stop

After the emergency stop switch is pressed, press the “enter” key to enter the sewing interface. The trial sewing interface can be used to forward the needle number, backward or thread trimming. For operation steps, refer to [2.11 Trial Sewing Operation].

QUICK (P) PATTERN OPERATION

Pattern Data Login

Quick pattern is abbreviated as P pattern, which consists of an ordinary pattern and related pattern sewing parameters (X zoom rate, Y zoom rate, speed limit, etc.). P-patterns does not need to adjust everytime.

P pattern data login interface is shown on the right.

Up to 255 P patterns can be registered.

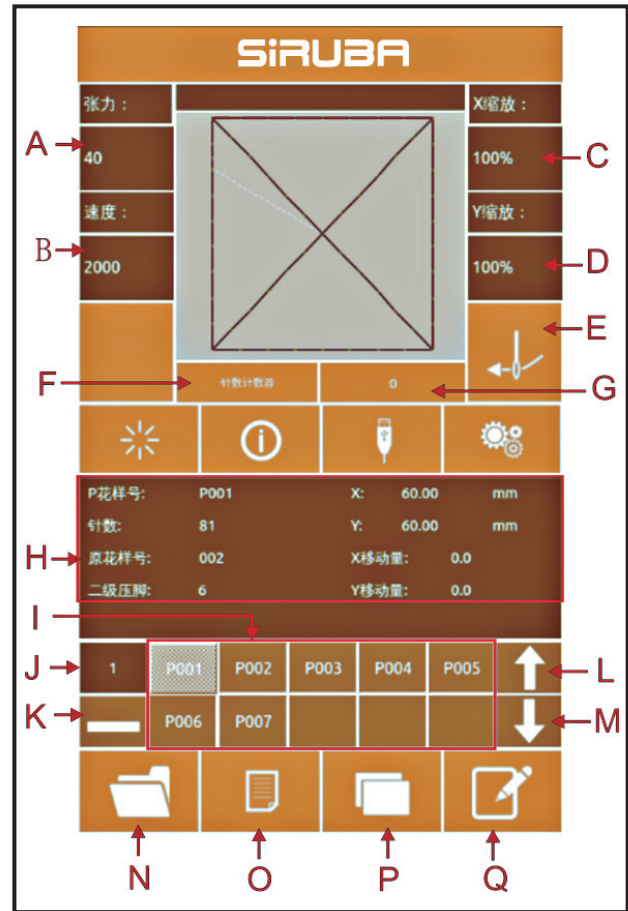

Function Description:

No.	Function	Content
A	Tension	Display current tension
B	Speed Value	Display current pattern speed value
C	X Zoom Rate	Up to 14 characters can be entered
D	Y Zoom Rate	Press to lower down external presser foot
E	Threading	Press to show red threading mode., do operate other operation
F	Counter Mode	Divided into sewing counter and needle counter. Press for quick switch counter mode and count display
G	Counter Value	Display the corresponding current count value according to the counter mode
H	P Pattern Information Display	Display current P pattern sewing information.
I	Registered P Pattern	Quick switch for P pattern
J	P Pattern number of pages	Number of pages of current P patter displayed, and button can sequentially switch to P pattern page number
K	P Patter Delete Button	Press to delete the selected P pattern.
L	P Patter Page Forward	Press P pattern button to have the page forward
M	P Pattern Page Backward	Press P pattern button to have the page backward
N	Ordinary Pattern Select Button	Press to select registered ordinary pattern
O	Ordinary Pattern Register Button	Register new ordinary pattern
P	P Pattern Copy Button	Copy current P pattern content to an empty pattern number
Q	Pattern Naming Key	Naming current pattern

Pattern Editing

① Enter P pattern edit interface

Press  to select ordinary pattern. Edit ordinary pattern parameter, modify the zoom rate, intermediate pressure foot, tension, speed and other parameter values. After modification register P pattern and refer to [2.10 P pattern registration] then new pattern will be registered.

② Edit Project Data

Select the item you want to change and set the value.

	Category	Value Range	Initial Value
A	Sewing Tension	0~120	40
B	Sewing Speed	400~3000rpm	2000rpm
C	X direction zoom in	1%~400%	100.0%
D	Y direct zoon out	1%~400%	100.0%
E	Intermediate presser foot height	0.0~7.0mm	2.0mm
F	Presser foot height	10~25mm	17mm
G	Pattern naming	String	None
H	XY offset value	---	0

③ Confirm Data Changed

Set XY offset direction as example, move XY starting point through keypad. Press confirm

button  to complete operation. Refer to [2.13

Adjusting the sewing point operation]

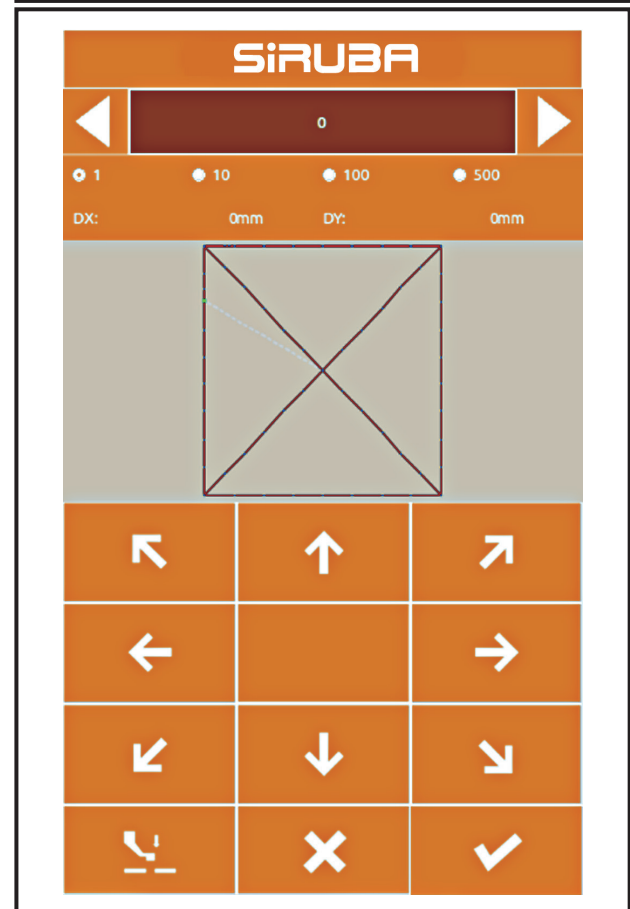
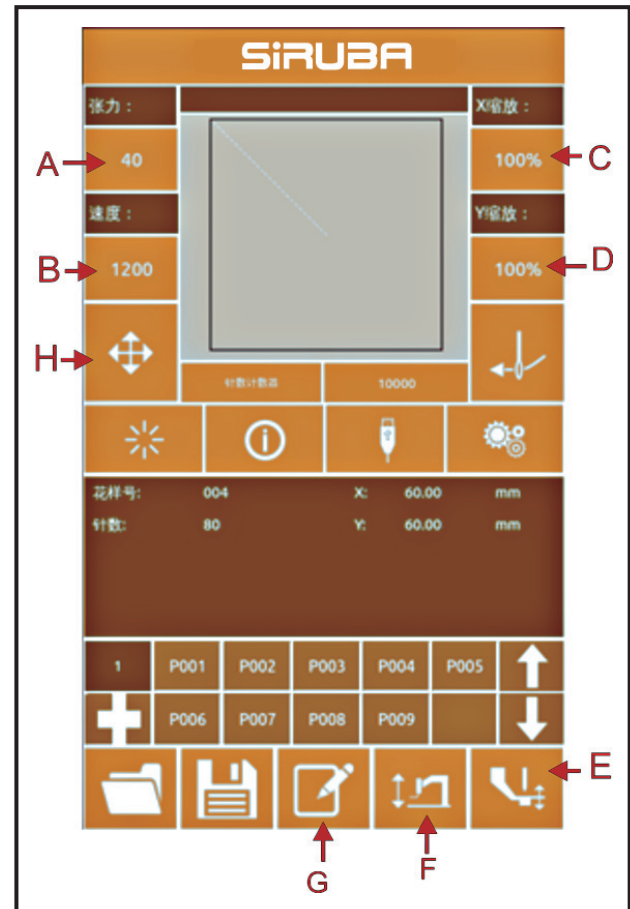

P Pattern Sewing

At P pattern data login interface, press  to enter sewing interface

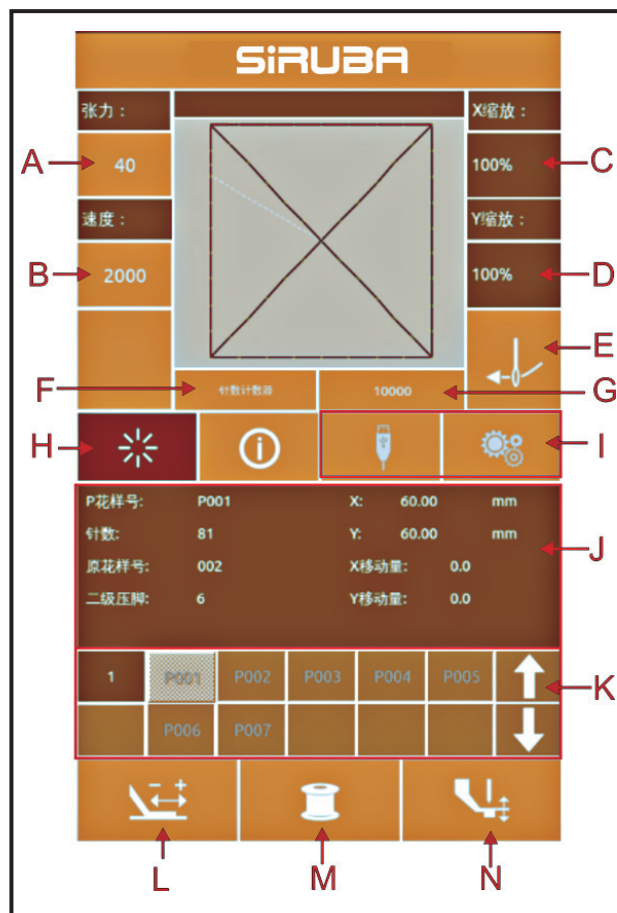

Function Description:

No.	Function	Content
A	Tension Button	Press the button to enter tension setting interface. Adjust sewing tension value
B	Speed Button	Set current sewing speed.
C	X Direction Zoom Display	Display current X direction zoom rate
D	Y Direction Zoom Display	Display current Y direction zoom rate
E	Threading Button	Press E button then turned red  to enter threading mode. No other operation can be made under threading mode.
F	Counter Mode Button	For quick switch to sewing counter/ stitch counter”
G	Counter Display Button	Corresponding stitch count will be display based on mode in F button. Press G to clear current stitching value
H	Pattern Confirmation Button	Switch “Pattern Input Status/ Sewing Status”
I	Inoperable Button	Operation cannot be made under current status
J	Pattern Information Display	Display current pattern parameter
K	Inoperable Button	Operation cannot be made under current status
L	Test Sewing Button	Press to enter test sewing interface to confirm pattern stitching
M	Winding Button	Press for winding interface
N	Intermediate Presser Height Button	Press to enter intermediate presser foot height setting interface to adjust height during sewing operation.

COMBINATION © PATTERN OPERATION

C pattern data register

Combination pattern abbreviated as C patter, which composed by a set of P patter. Each of the C patterns can enter maximum 6 sub-patterns. Up to 50 sets of C patterns can be registered.

As shown on right figure

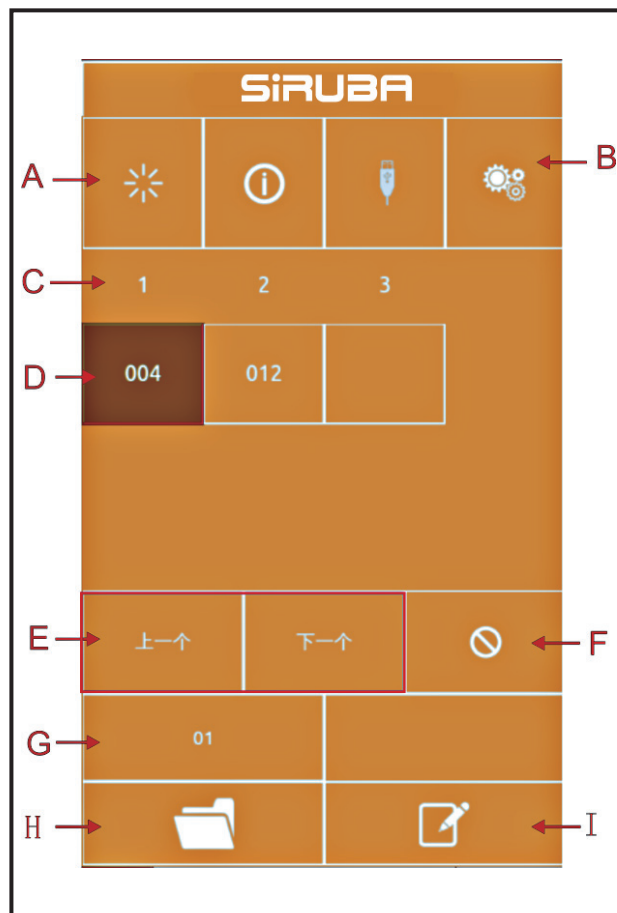

Function Description :

No.	Function	Content
A	Confirm Button	Enter sewing mode
B	Duplicate C Pattern	Duplicate current C pattern content to empty pattern number
C	Sewing Sequence Display	Display current selected pattern sewing sequence. Blue color display represent starting pattern.
D	C Pattern Selection	Enter C pattern editing interface.
E	Page Button	Up to 30 C pattern can be registered and up to 6 pattern can be displayed in each page
F	Delete Button	Delete C pattern sequence
G	C Pattern Number Selection	Display current selected pattern number. Press to enter C pattern selection interface
H	C Pattern Registration	Register new pattern combination
I	Patter Naming	Enter desire name
J	C Pattern Name	Display C pattern name

Edit C Pattern

① Enter C pattern editing interface

Under C pattern data register interface, press A to enter C pattern editing interface.

Since no registered P pattern in initial mode, the first P pattern file would display in empty.

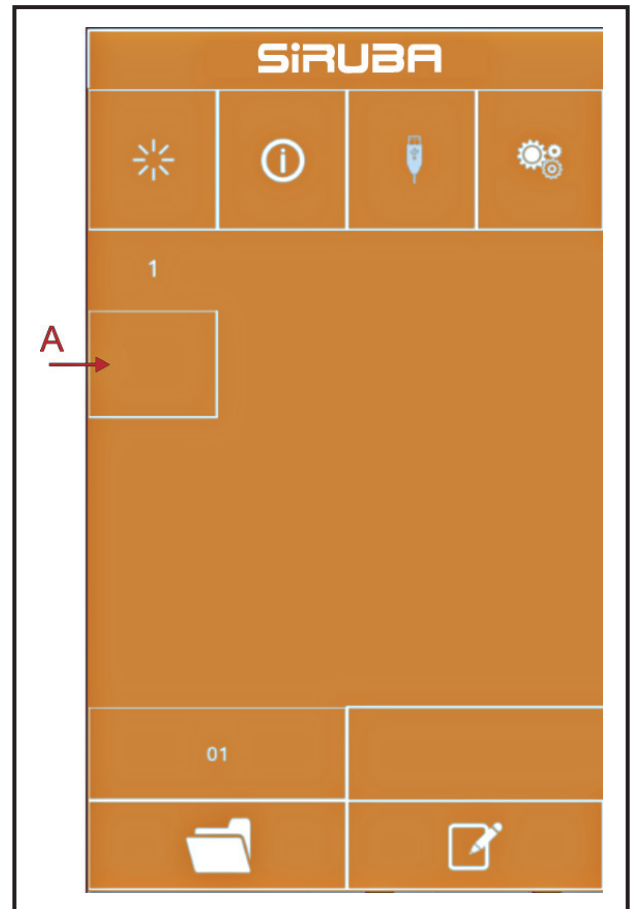

② Select Pattern

C pattern editing interface as shown in right picture. Select desire P pattern in B area. Press

confirm button  to finish selection.

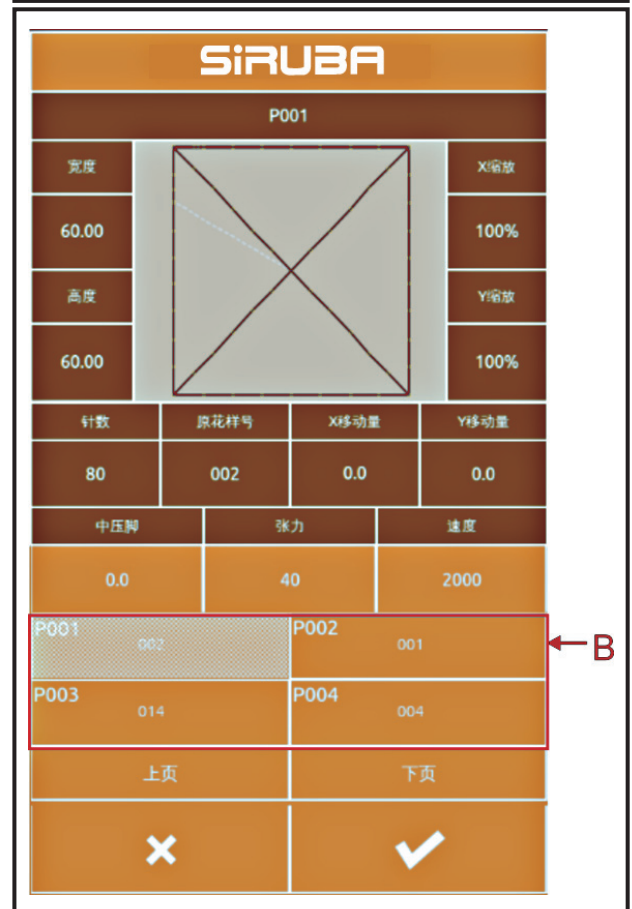

③ Repeat Register Remaining Patterns

After pattern registration is confirmed. Next pattern selection button C as shown in the picture (operation is same as above). It can repeatedly register remaining pattern.

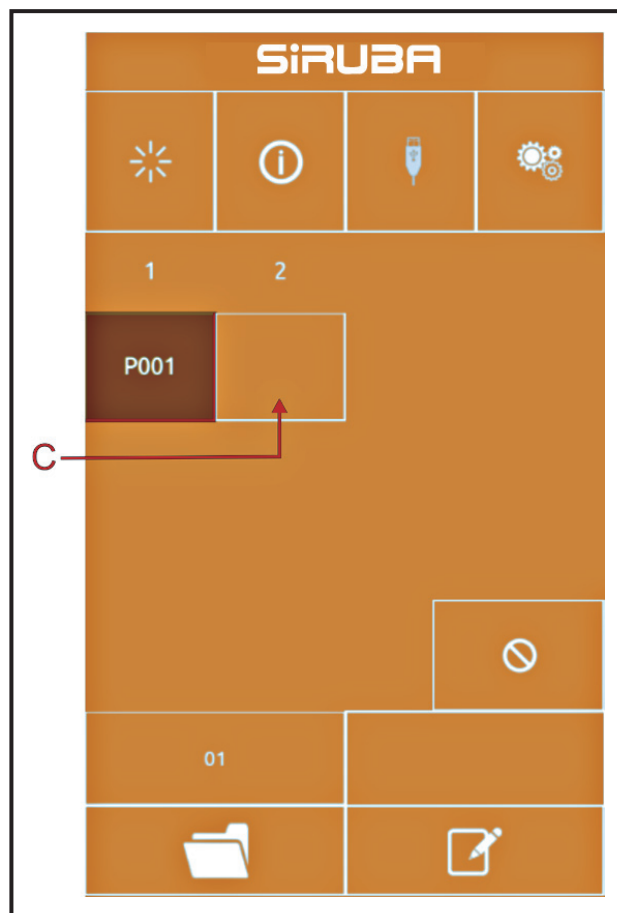

C Pattern Select

① Enter C Pattern Selection Interface

Press icon A to enter C pattern selection interface as shown in right figure

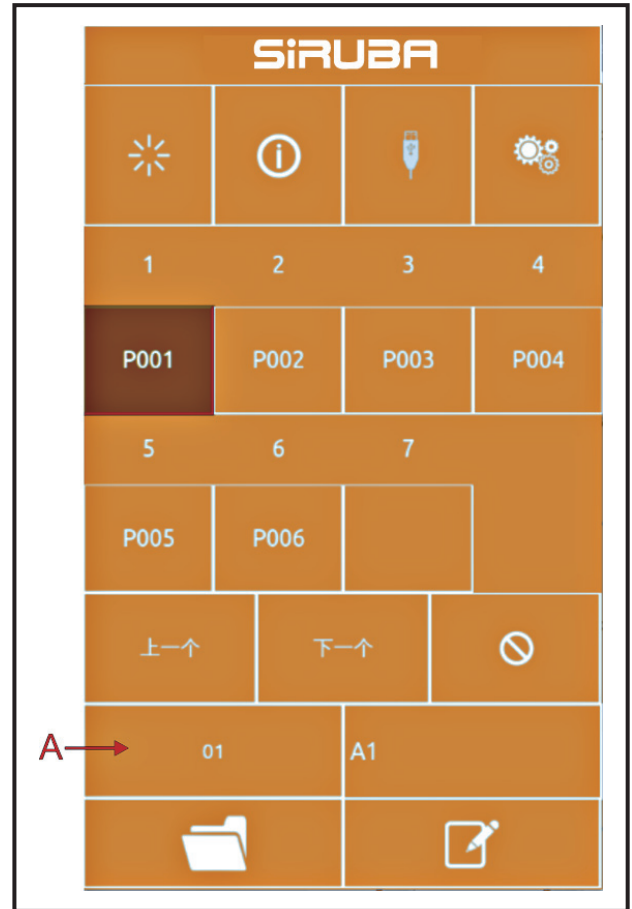

② Select C Pattern Number

Picture on right figure is C pattern selection interface. Press B button to change P pattern sequence.

Select desire C pattern number then press confirm button  to finish selection.

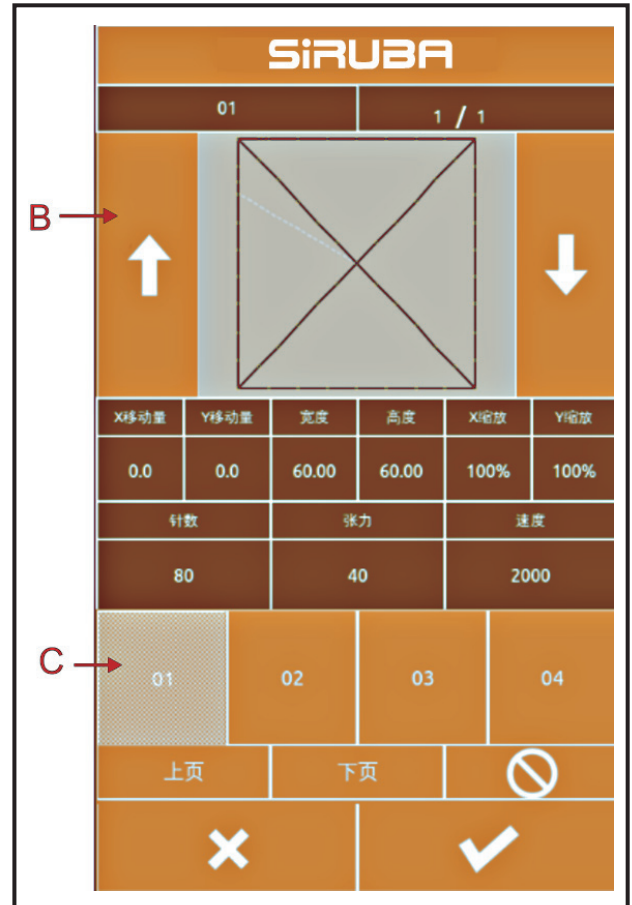

C 花樣縫製

Under C pattern data register interface

press  to enter sewing interface (as shown in right figure)

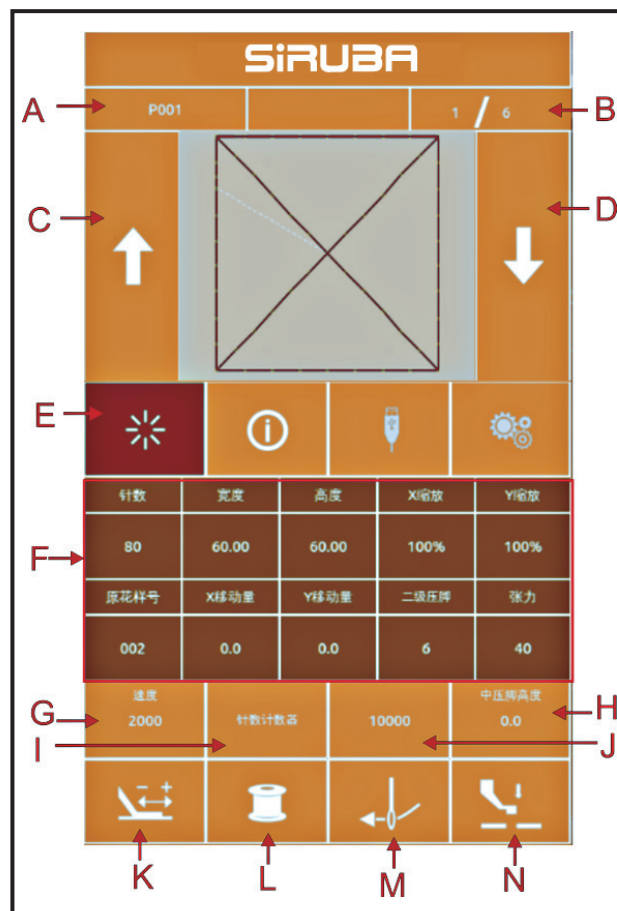

Function Description :

No.	Function	Content
A	Sewing Patter Number display	Display current C pattern register number
B	Sewing Sequence Display	Display current sewing pattern sequence
C	Sewing Pattern Switch Button	Switch to previous pattern
D	Sewing Pattern Switch Button	Switich to next pattern
E	Pattern Confirm Button	Switch C pattern interface and sewing interface
F	Pattern Information Display	Display current sewing pattern sequence parameter
G	Sewing Speed	Adjust current sewing pattern sewing speed
H	Intermediate Presser Foot Height Button	Adjust current sewing pattern sequence intermediate presser foot height
I	Counter Mode Button	Adjust current counter mode "sewing counter/stitch counter
J	Pattern Counter Display	Based on "I" setting to display corresponding pieces/stitches
K	Sewing Test Button	Press to enter sewing test interface and confirm current sewing pattern sequence stitching direction
L	Winding Button	Press to enter winding interface
M	Threading Button	Button turned red  after pressing and enter threading mode. No operation can be done in threading mode
N	Intermediate Presser Foot riase/drop Button	Control intermediate presser foot raise/drop

PATTERN EDITING

Enter Sewing Pattern Editing Mode

Press normal sewing to switch data register interface and mode selection interface (as shown on right figure). Detail setting and editing can be done under this interface.

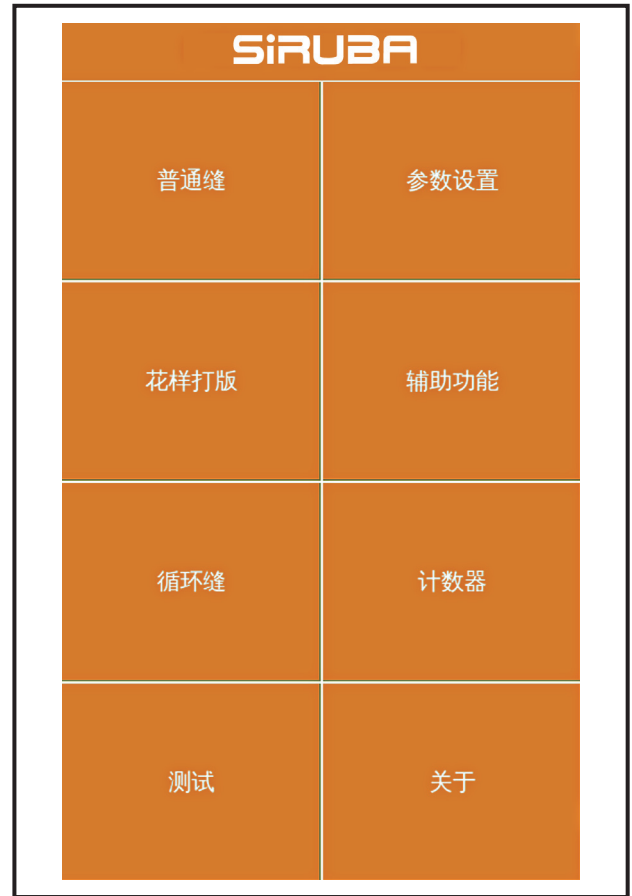

Press pattern making button to enter pattern editing interface.

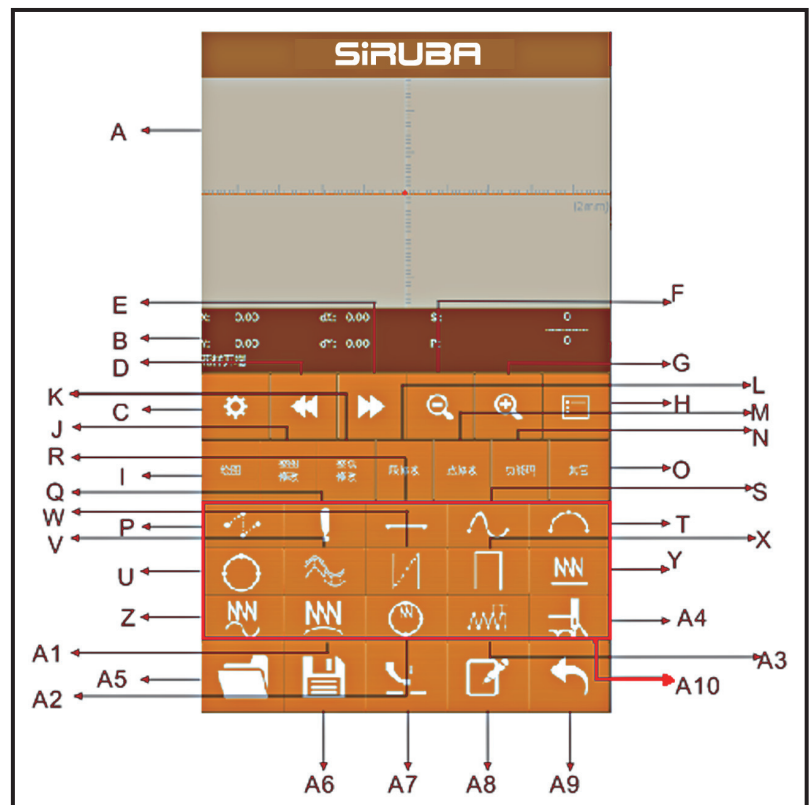

Function Description :

No.	Function	Content
A	Pattern Display Area	Display pattern
B	Current Needle Position Status Area	Display current needle position information
C	Property Setting	Return needle property setting
D	Fabric Feeding Backward	Current needle position move backward
E	Fabric Feeding Forward	Current needle position move forward
F	Zoom-out Display	Pattern zoom-in display
G	Zoom-in Display	Pattern zoom-out display
H	Function List	List of pattern making function
I	Drawing	A10 area shows drawing related button
J	Whole Pattern Modification	A10 area shows pattern editing related button
K	Line Modification	A10 area shows line modification related button
L	Period Modification	A10 area shows period modification related button
M	Point Modification	A10 area shows point modification related button
N	Function Code	A10 area shows function code related button
O	Others	A10 area shows other related button
P	Empty Feed	Empty feed drawing
Q	Point Sewing	Point drawing
R	Straight Sewing	Straight line drawing
S	Curve Sewing	Curve drawing
T	Arc Sewing	Arc drawing
U	Circle Sewing	Circle drawing
V	Multiple Sewing	Multiple sewing drawing
W	Same Direction Double Repeat Sewing	Same direction double repeat drawing
X	Opposite Direction Double Repeat Sewing	Opposite direction double repeat drawing
Y	Straight Curve Sewing	Straight curve drawing
Z	Curve Tortuous Sewing	Curve tortuous drawing
A1	Arc Tortuous Sewing	Arc tortuous drawing
A2	Circle Tortuous Sewing	Circle tortuous drawing
A3	Straight Tortuous Sewing 2	Straight tortuous drawing 2 (Multiple point for each of the parts)
A4	Jump Sewing	Jump drawing
A5	Open	Open pattern document
A6	Save	Save current pattern file
A7	Medium Presser Foot Lift	Lift or lower intermediate presser foot
A8	Naming	Create pattern name
A9	Quit	Quit pattern drawing
A10	Dynamic Button Display Area	According to the different choices of buttons (I, G, K, L, M, N, O), the corresponding related buttons are displayed.

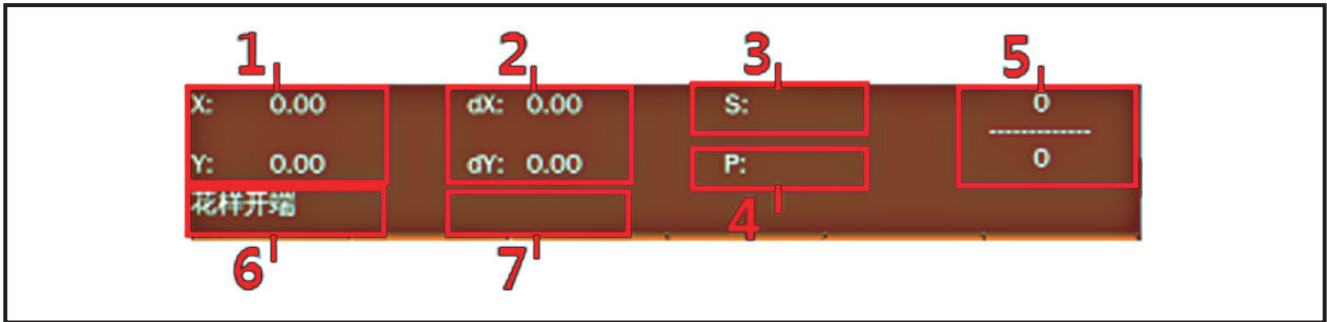

Function Description :

No.	Item	Content
1	Absolute Coordinate	Indicates absolute coordinates of the origin from the current needle position.
2	Relative Coordinate	Indicates relative coordinates of current needle position.
3	Speed	Indicates the sewing speed or empty stitch speed of current point.
4	Spacing	Indicates current factor sewing stitch length.
5	Stitch Number	The numerator indicates the current number of stitches, and the denominator indicates the total number of stitches.
6	Needle Drop Category	Indicates the type of needle drop position.
		The beginning of the pattern indicates the starting position of the pattern.
		The middle point of the line segment indicates the midway point of a line (Not a vertex or a line segment terminal).
		Vertex represent polyline is the vertex point.
		Line segment terminal, indicating the end position of a line.
7	Thread or Function Code Category	While entering sewing data, display shows type of thread (empty feed, polyline seam, curve seam, etc). When function code is displayed, it shows current code function (thread trimming, etc)

Pattern Edition

Press below pattern to use pattern editing function.

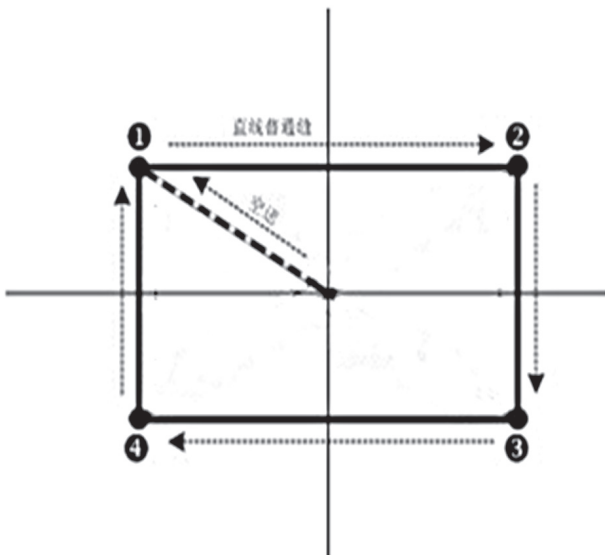

Entering Point :

	X (mm)	Y (mm)
1	-40.00	25.00
2	40.00	25.00
3	40.00	-25.00
4	-40.00	-25.00

Entering sequence as shown on left figure.

① Empty Feed Stitch Input

Press empty feeding button  under standard pattern editing interface.

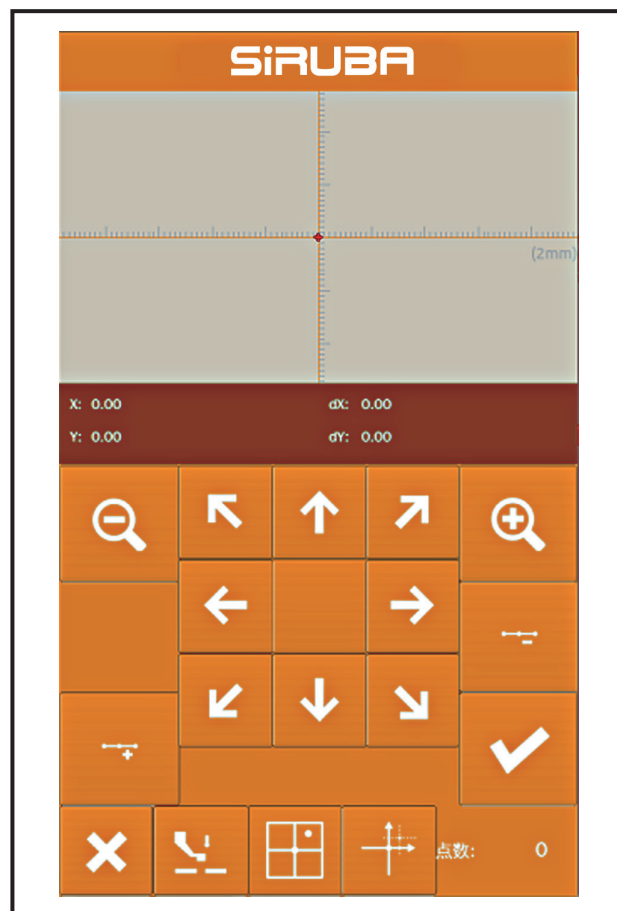

Specify the interface in the empty position, press



to move button, move the cursor (needle position) to (-40,25), press the button to confirm.

Return to the pattern editing standard interface and display the empty feed stitch (as shown in the

right figure).



② Straight Line Normal Sewing Input

After pressing straight line sewing button  under pattern editing interface, it will enter straight line normal sewing interface as shown on right figure. Press 3, 0 digit button in sequence to adjust stitch length to “3.0” . Press confirm button to save and return to straight line normal sewing setting interface.

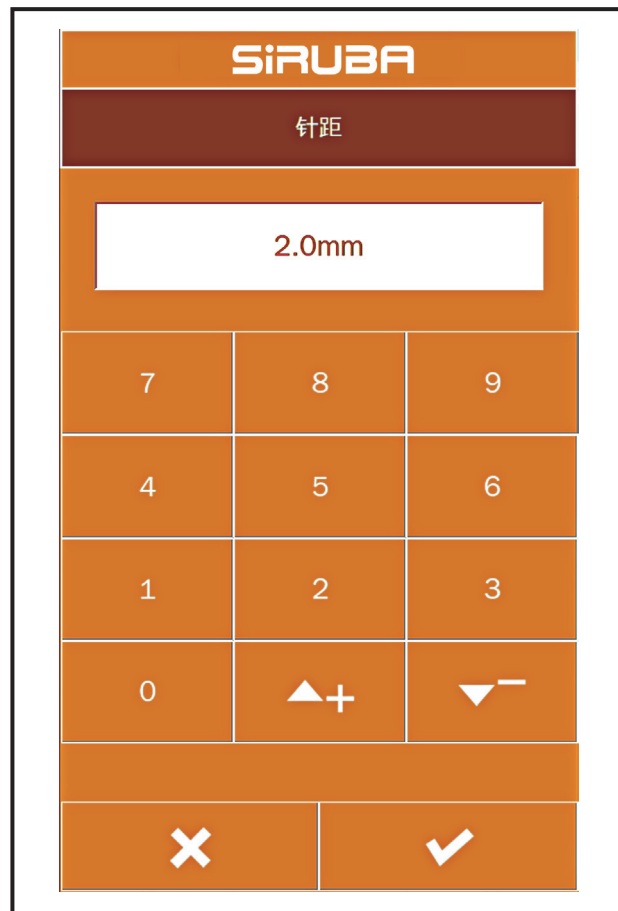



After confirm stitch length display value “3.0mm” , press confirm button  to entr straight line normal sewing position setting interface.

Press moving button to move the cursor (needle position) from point 1 to point 2. Then press insert

point button  . Repeat moving operation as mentioned above. Move the cursor sequentially from

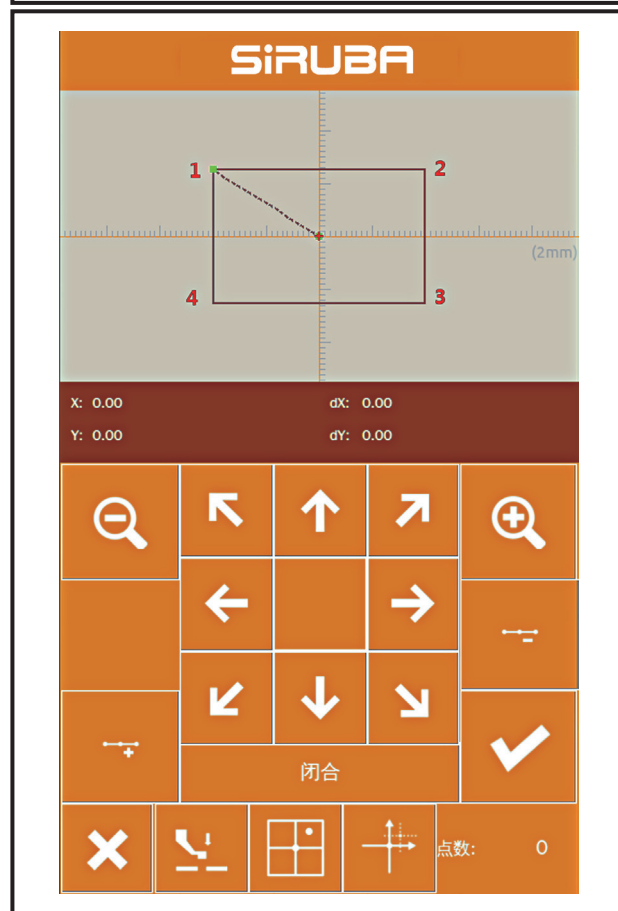
1 → 2 → 3 → 4 as shown on right figure.



After pattern is confirmed, press  to generate pattern information and return to pattern editing standard interface to display pattern.



③ Save Pattern

Press  to enter pattern design saving interface and save the edited pattern as shown on right figure.

System automatically set the sample number. User

may also enter desired value through numeric

kepad. Press  to save the pattern.

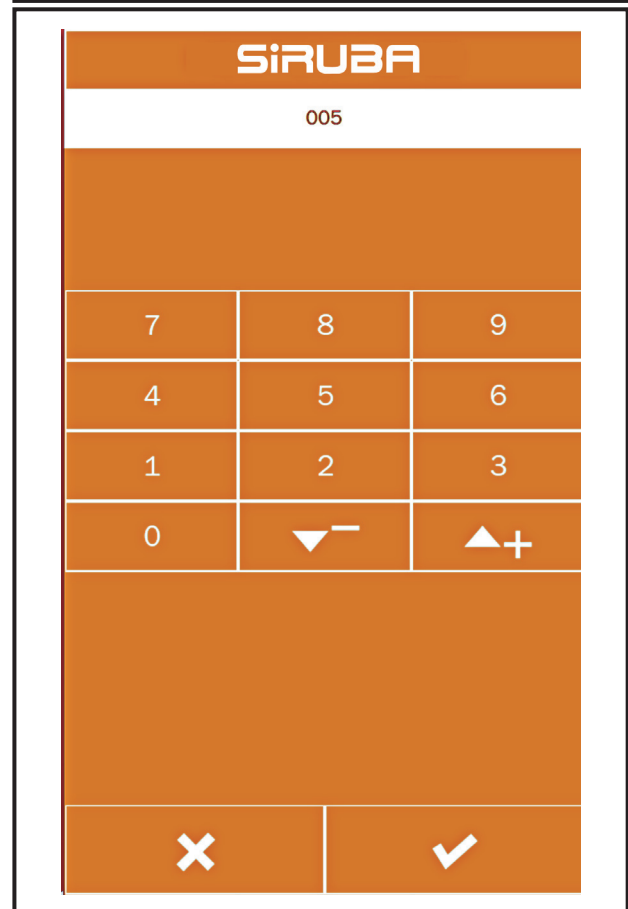

Pattern Editing

1: Entire Pattern Modification: Press entire pattern editing button as below function buttons

- (A): Move starting point button
- (B): Modify entire pattern stitch length
- (C): Move to second origin point

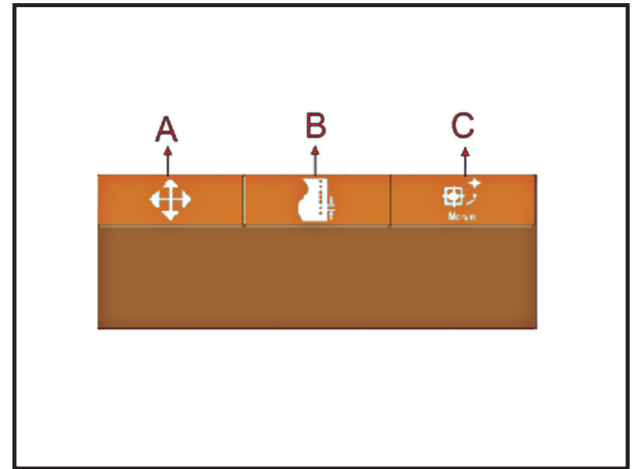

2: Entire line modification: Press entire line to modify the button. Dynamic button display area as below function buttons

- (A): Modify stitch length of the current line
- (B): Move current line
- (C): Move multiple lines
- (D): Copy current line
- (E): Delete current line
- (F): Move current line and all the lines behind

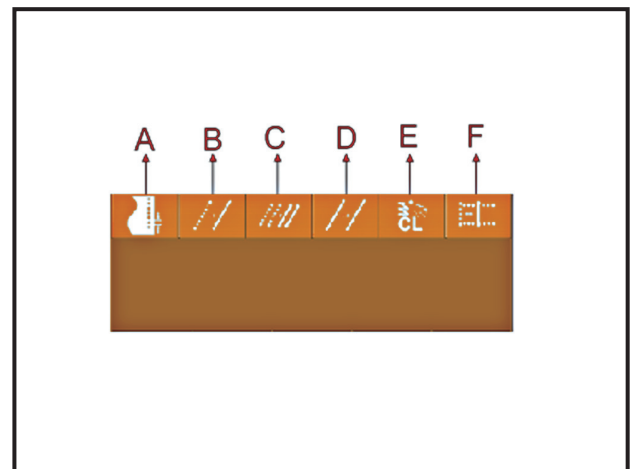

3: Segment modification button: Press segment modify button. Dynamic button display area as below function buttons

- (A): Move section
- (B): Section modification
- (C): Delete section

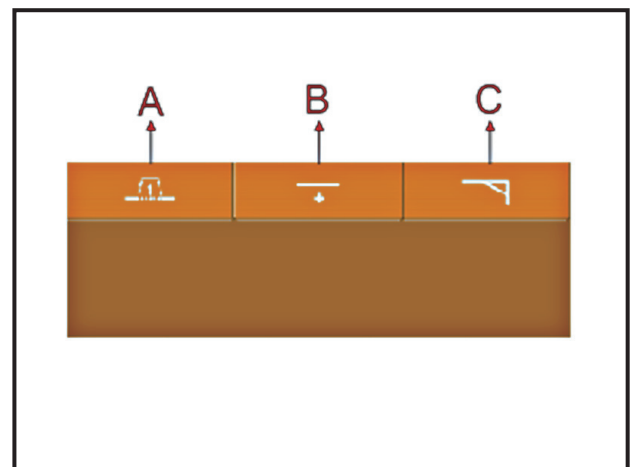

4: Point modify button: press point modify button.
Dynamic button display area as below function buttons

- (A): Moving point
- (B): Add points
- (C): Delete point

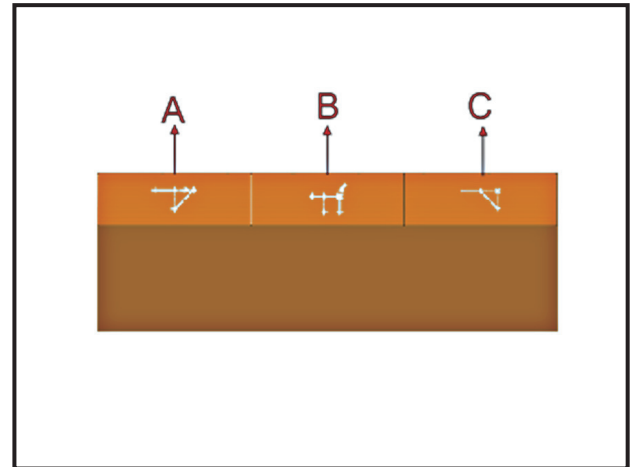

5: Function Code Button: Press function code button.
Dynamic button display area as below function buttons

- (A): Trimming
- (B): Second origin point
- (C): Stop halfway
- (D): Line tension reference value
- (E): Intermediate presser foot height reference value
- (F): Thread tension
- (G): Intermediate presser foot height
- (H): Delete function code
- (I): Sewing speed
- (J): Empty feed speed
- (K): Sewing machine stop
- (L): External input
- (M): External output
- (N): Edit function code
- (O): Skid, flip and other dedicated expansion equipment.

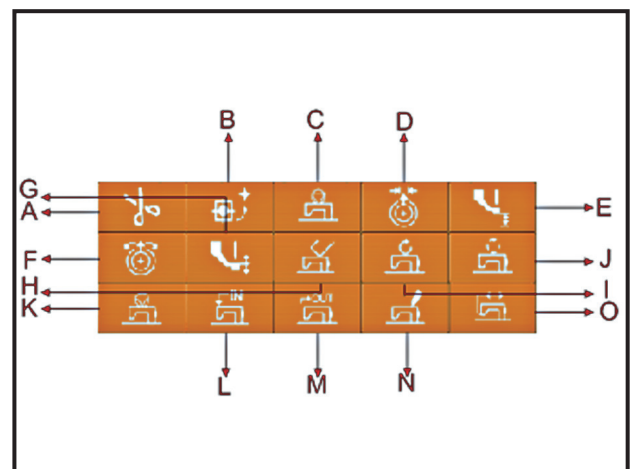

6: Others: Press other buttons. Dynamic button display area as below function buttons

- (A): Move to designated needle
- (B): Replace template function
- (C): Move empty feed

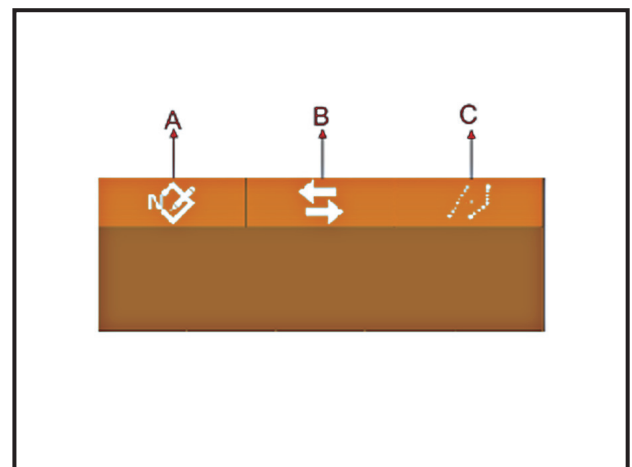

Exit Pattern Edit Mode

Under pattern editing standard interface press  to enter mode selection interface as shown on right figure.

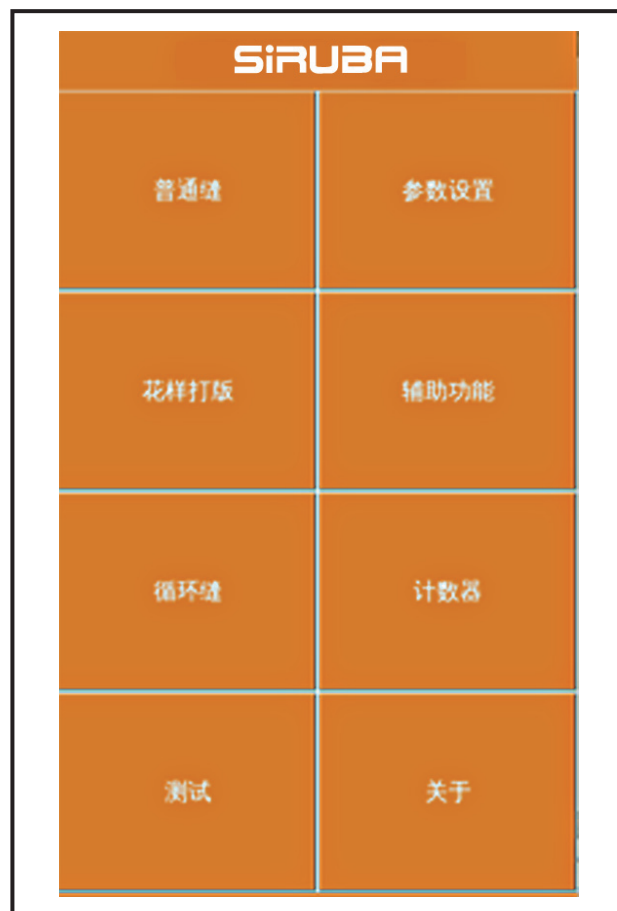

INFORMATION FUNCTION

Check Version Information

1 Information Display Interface

Press information button (A) in data login interface.

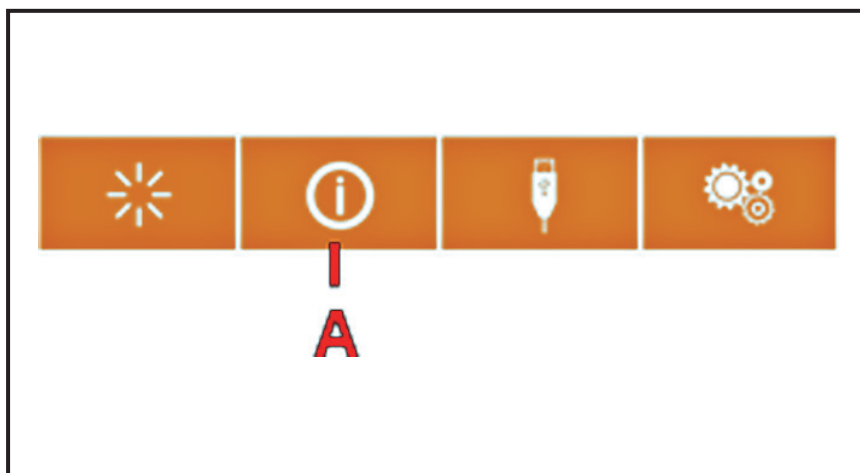

2 Version Display Interface

Press version button under information interface to check version information.

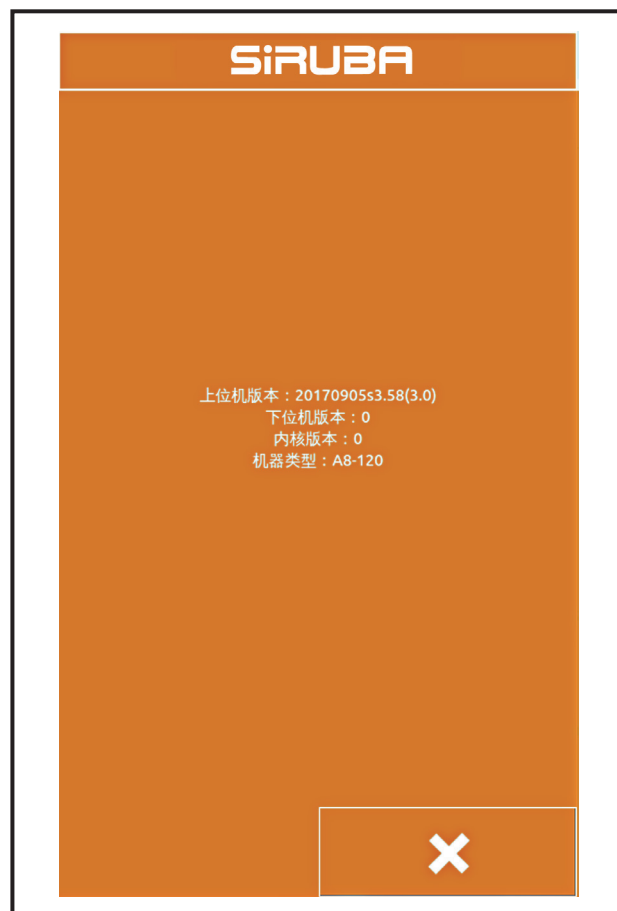
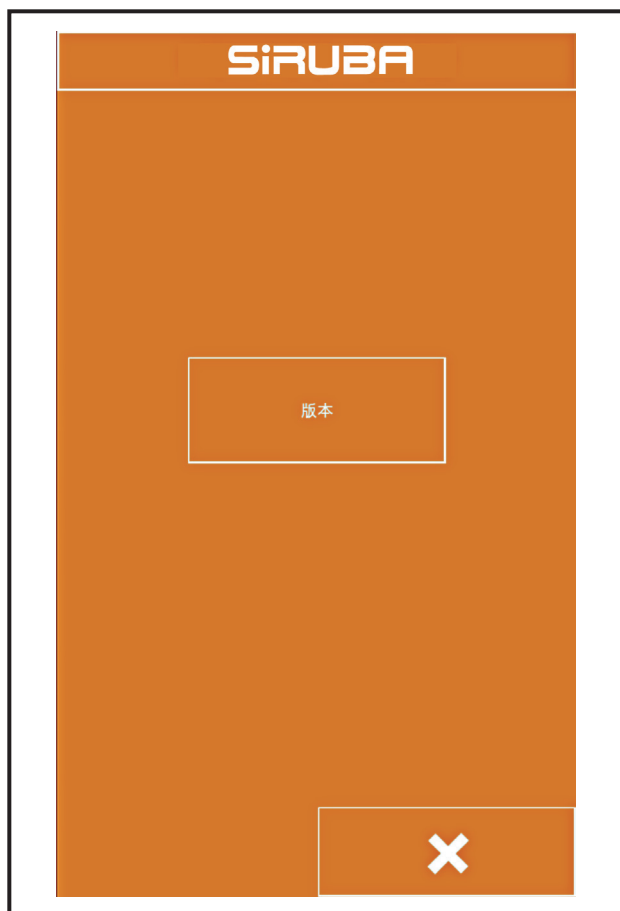

COMMUNICATION FUNCTION

Communication function as below :

Copy other sewing data or drawing and paste to control panel through USB flash drive.

Copy sewing data from control panel to USB flash drive.

About data that can be processed

Sewing information that can be processed as below:

Data Type	Standard Format
VDT	VD00[0-9][0-9][1-9].VDT
sew	ISMS0[0-9][0-9][1-9].sew

Data Transfer

- Copy pattern to control panel through USB flash drive



In the data login interface, press 

communication button to display the

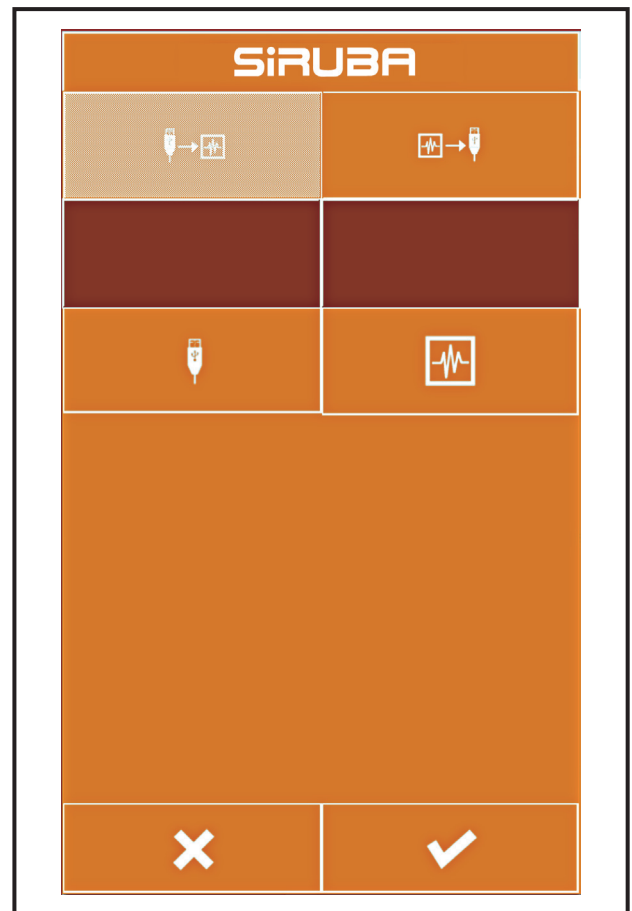

communication interface, as shown on right figure.

- Select  button, this button means to copy the pattern file from the USB flash drive to the control panel;

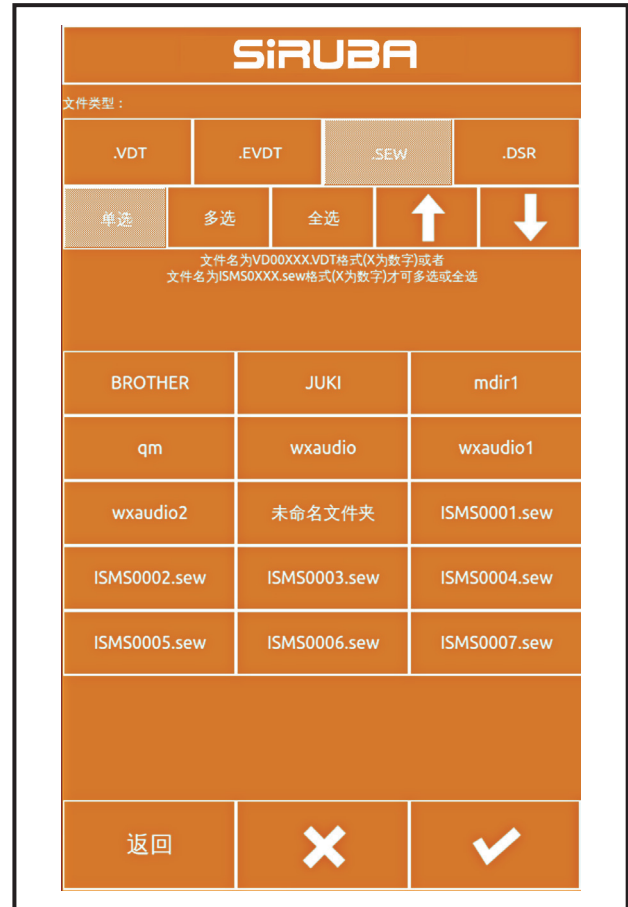

(2) Press the USB flash drive button  to display the USB flash drive file interface, as shown on the right. Find desired file to copy and press the  button.



(3) Press the operation panel button  to display the input file interface. As shown in the figure on the right, this file number is the file number after the file is copied to the operation panel. Press  the OK button after entering the file number.



(4) After select file and finish input from operation

panel (as shown on right figure). Press confirm

button  . File will copied to operation

panel from USB flash drive.

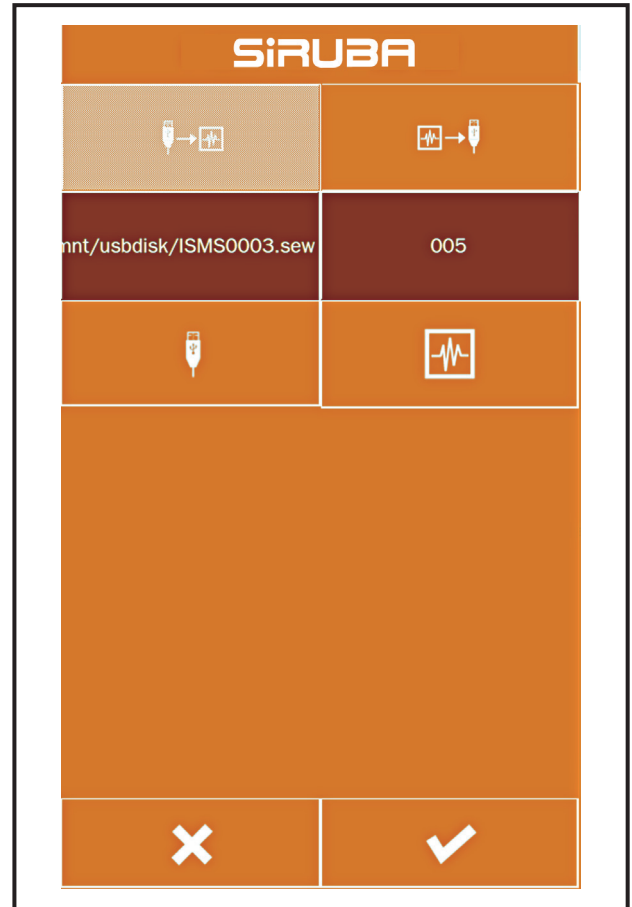

2. Copy data from operation panel to USB flash drive

After pressing communication button  in data login interface, communication interface



displayed as shown on right figure.

(1) Select  button, this button means to copy

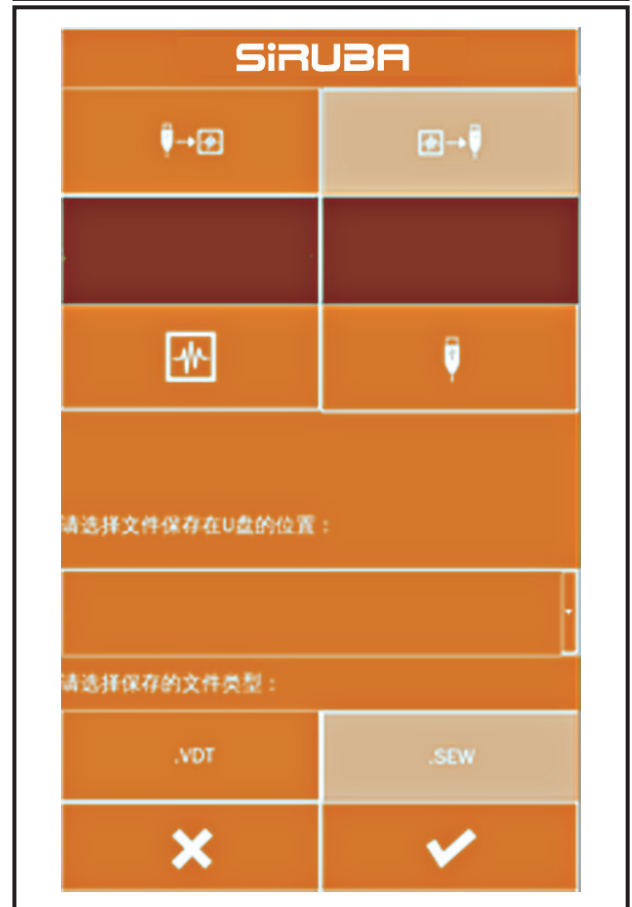

the pattern file from operation panel to USB

flash drive.

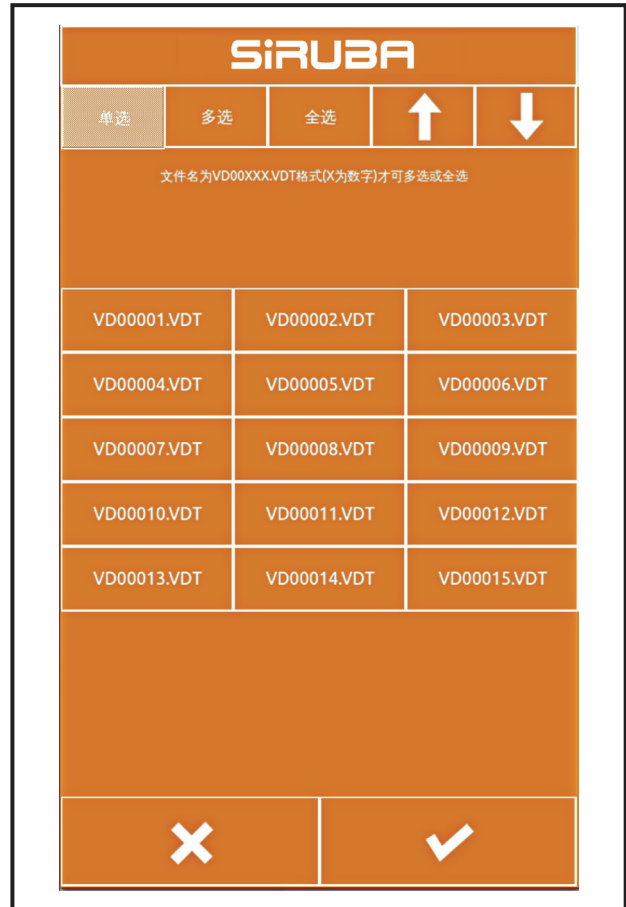

(2) Press operation panel button  to display selection operation panel interface (as shown on right figure). Find desired file need to copy and press confirm button  .



(3) Press USB flash drive button  to display input file interface. This file number is the file number after the file is copied to USB. After entering the file number, press the OK button  .

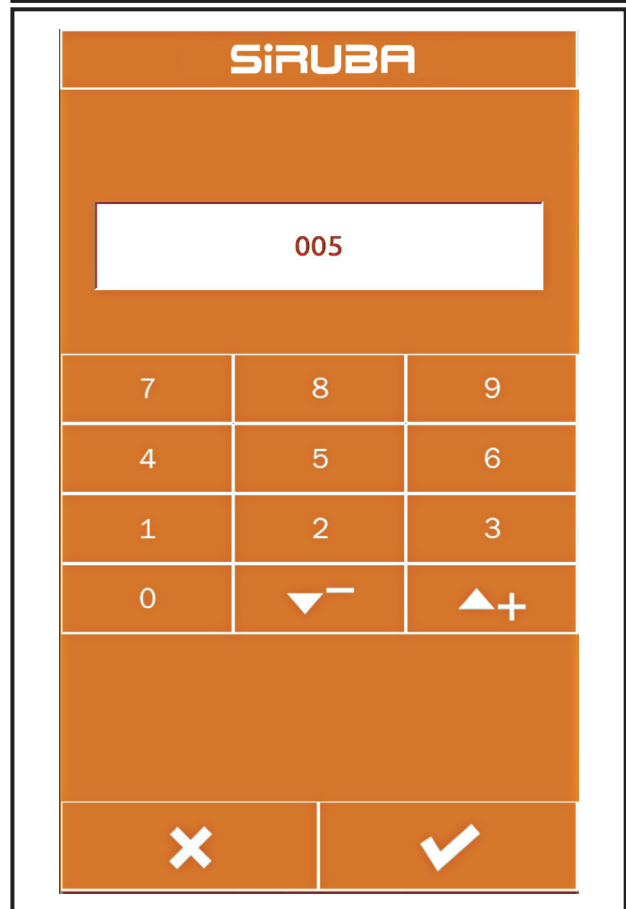

(4)After selecting file and finish entering file

number on USB flash drive, press OK button

. File will be copied to USB accordingly

as shown on right figure.

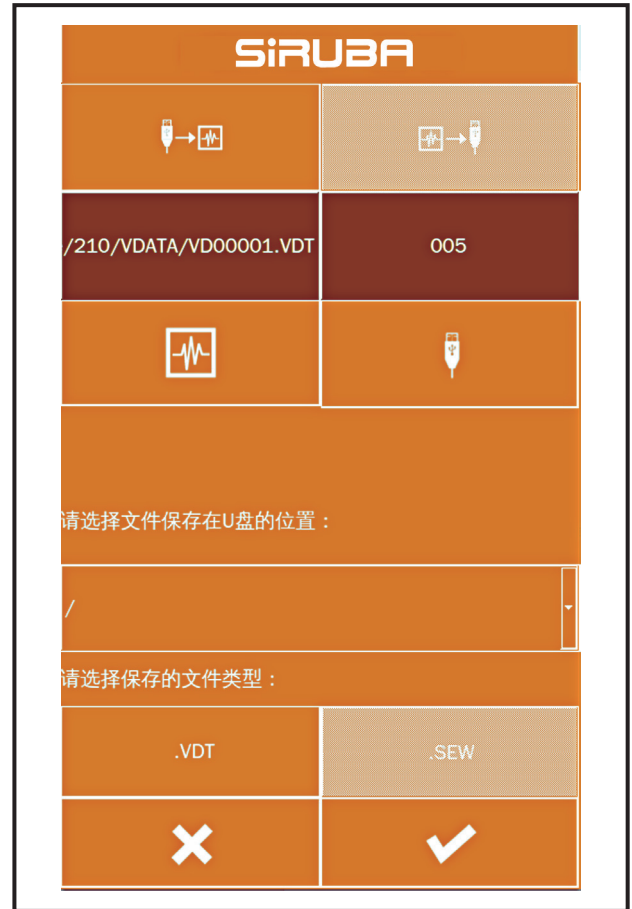

MODE AND PARAMETER SETTING

Mode Switch

Press  under normal sewing interface to enter setting interface (as shown on right figure). Mode can be switch under this interface.

Three mode: Normal stitching mode, pattern mode, Loop stitching mode

Normal Stitching Mode

Press Normal Stitching button to enter Normal Stitching mode.

Pattern Making Mode

Press pattern making button to enter pattern making mode. Edit pattern, modify patter, and drawing can be made under pattern making interface.

Loop Stitching Mode

Press loop stitch button to enter loop stitch interface.



Testing

Press test button to enter test interface as shown on right figure.

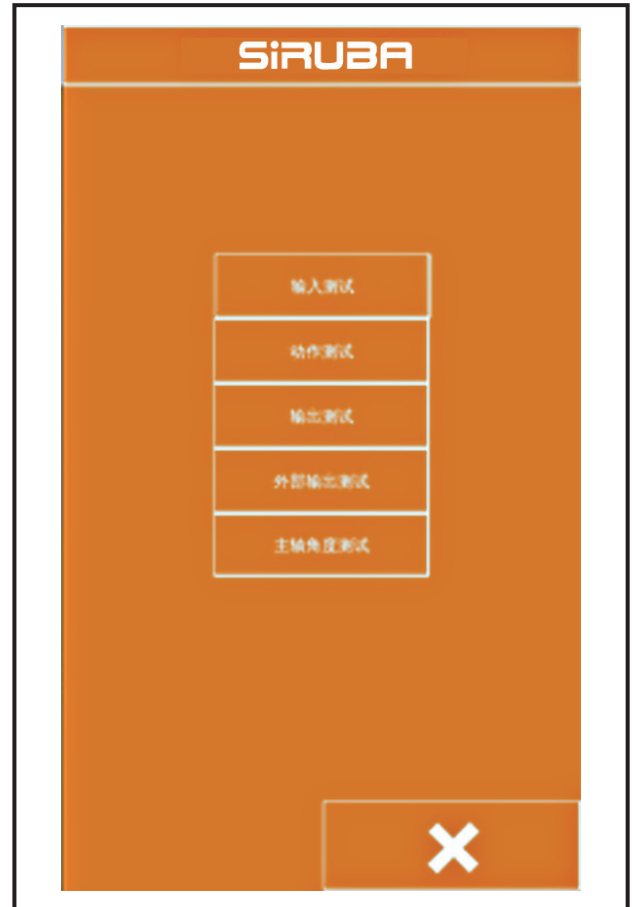

Enter Testing Data

Press test button to enter test interface as shown on right figure.

It may check X origin point, Y origin point, pedal switch, emergency stop switch, and broken thread detection status.

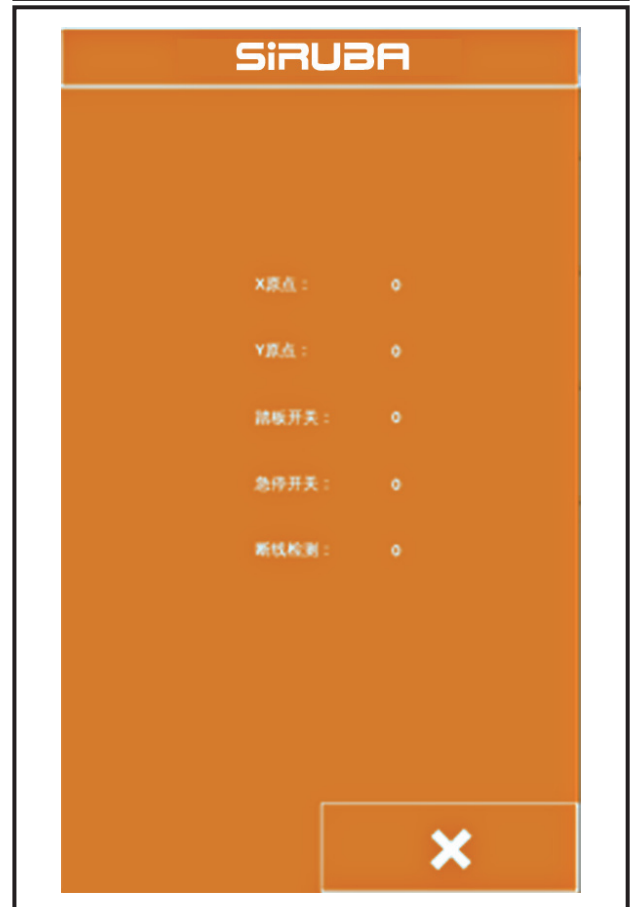

Movement Test

Press action test button to enter action test interface. Test X-axis movement action, Y-axis movement action, thread trimmer action, intermediate presser foot movement, and threading action.

 : X-axis movement action button

 : Y-axis movement action button

 : Trimmer button

 : Intermediate presser foot button

 : Threading button

Select test action button then click “+” or “-”, if all corresponding parts are moving properly it means function is normal. Press  to shut down testing.

Output Test

Press output testing button to enter output test interface. Click “+” or “-”, if all corresponding output valve are moving properly it means all function is normal. Press  to shut down testing.

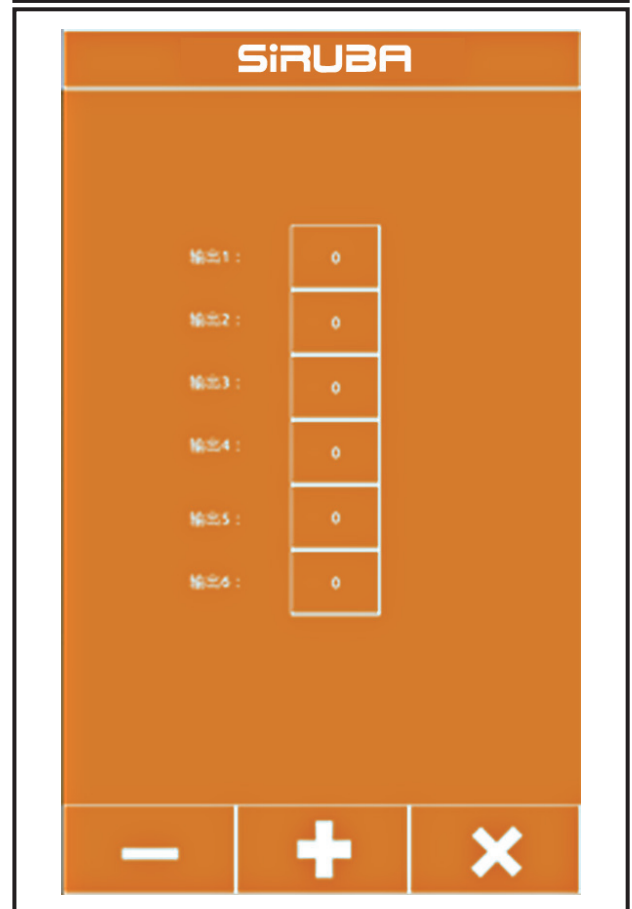
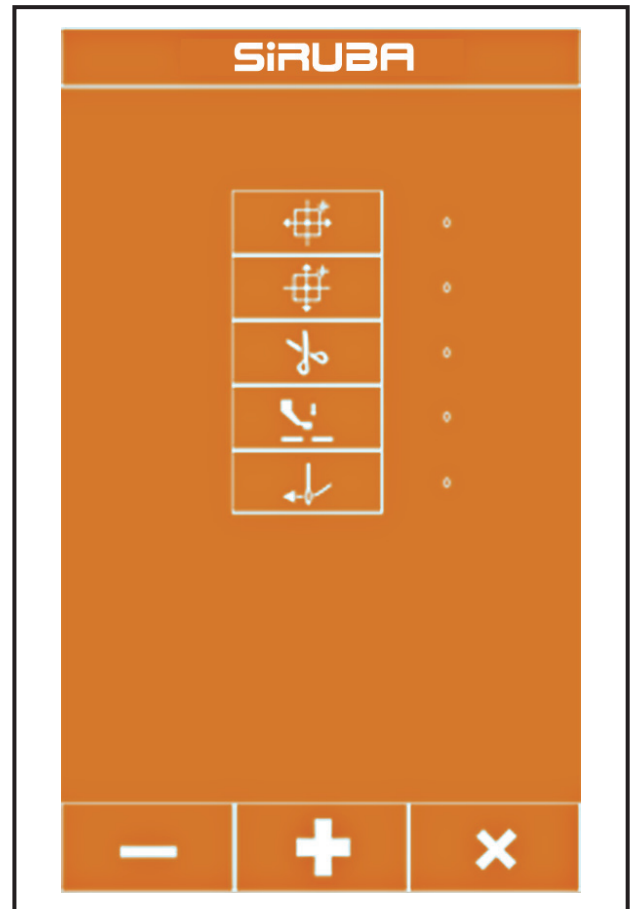

External Output Test

Press external output test button to enter external output test interface (As shown in the figure). After select external output port, press “+” and “-” button. If all corresponding external output port of the expansion board has action. It means external output port function is normal. Press  to shut down testing.

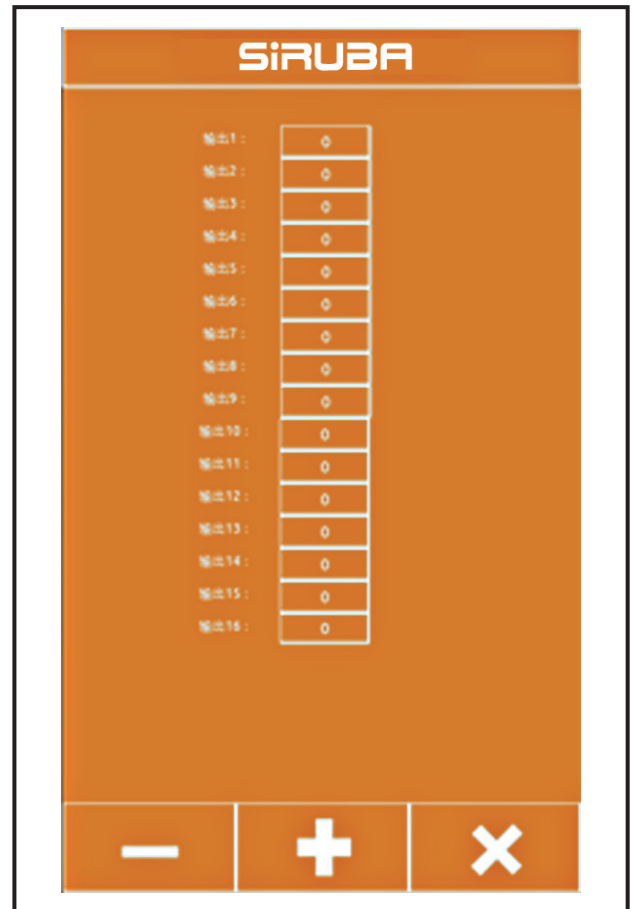

Spindle Angle Test

Press spindle angle test button to enter spindle angle test interface (As shown in the figure). You may check current spindle angle. By rotating machine spindle, spindle angle will also change as rotation.

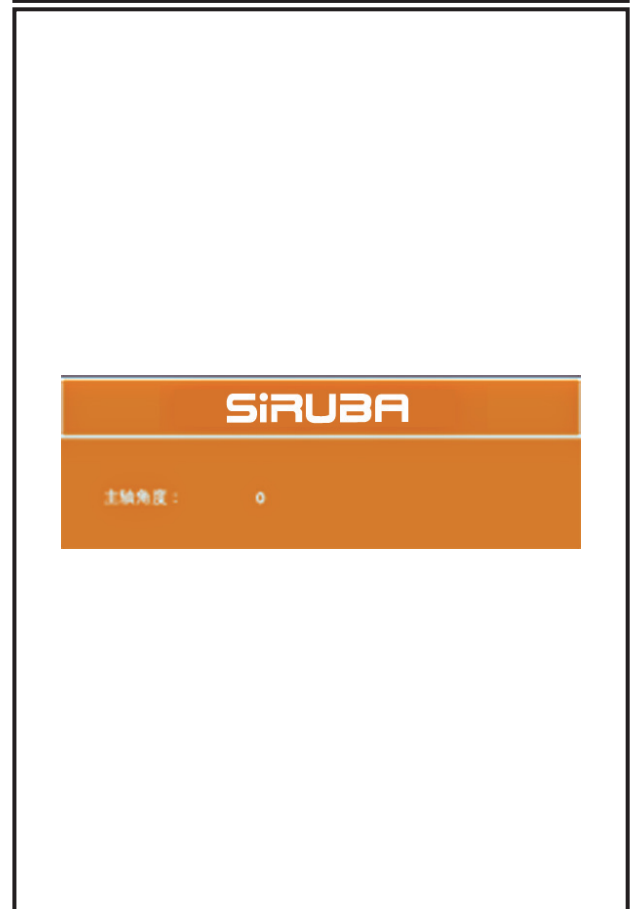



Parameter Setting



Click parameter setting button to enter parameter setting interface (as shown in the figure). The main function of the parameter setting is for some machine parameter setting and other options. Among all the setting, Basic Setting 1 is for common setting generally related to control panel. Basic Setting 2 are generally not related to control panel but panel only. Advanced Setting are some important setting which require advanced permission. User may enter the setting mode by entering password. Super Setting is generally set by manufacturer technician with super permission only.





Basic Setting 1

Click Basic Setting 1 to enter basic parameter setting

interface (as shown in figure). Using  and  to move next/back page. Select parameter button

that needs to be changed. Click  to check selected parameter information. Using 

and  to adjust parameter value. After finished press  to ensure the change. Click  to exit

basic parameter setting interface.

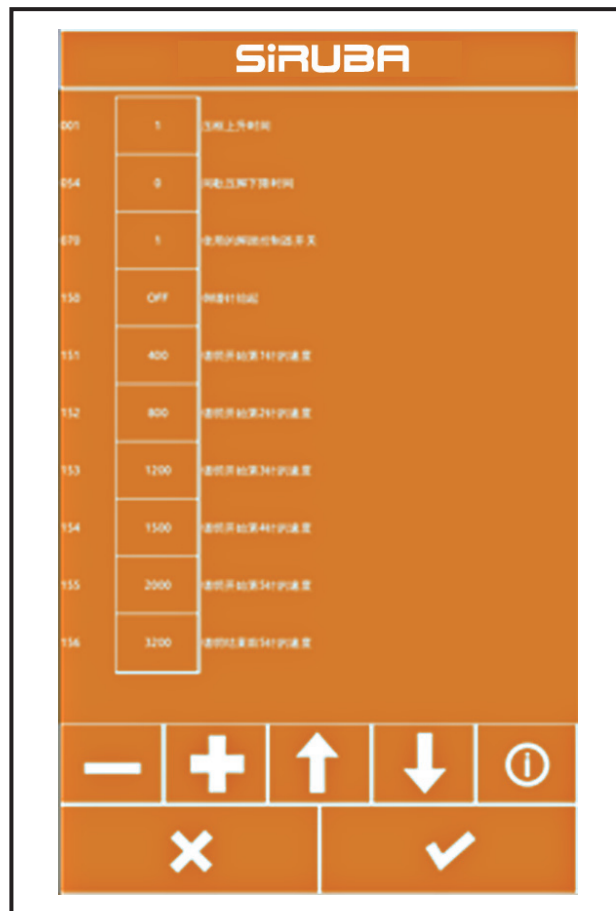

Basic Setting 1 parameter description as shown on below:

No.	Setting Range	Initial Value	Setting Unit	Setting Description
1	OFF/1/2	1	-	Frame rise time: Frame rise time after sewing OFF: No automatic rise 1: Rise after last needle position 2: Move to start sewing position and rise
54	0 ~ 2	0	1	Intermittent presser foot dropping time: 0: Through presser foot to activate dropping switch. But does not drop at fabric feeding retraction position. 1: Through presser foot to activate dropping switch. 2: Presser foot switch does not link, presser foot lower after sewing starts.
70	1 ~ 2	1	1	Use foot pedal as control switch 1. Foot controller switch (single step) 2. Double linkage foot controller switch (optional)
150	ON / OFF	OFF	-	Reverse sewing needle lift ON: Motor reverse when upper shaft stops and needle bar return to top position. [Note] When reverse needle is lifted, thread rod will stop at lower than usual position. Therefore, needle will be removed under different sewing conditions. OFF : Invalid

151	200 ~ 3200 (sti/min)	400	100	Sewing speed at first stitch starts
152	200 ~ 3200 (sti/min)	800	100	Sewing speed at second stitch starts
153	200 ~ 3200 (sti/min)	1200	100	Sewing speed at third stitch starts
154	200 ~ 3200 (sti/min)	1500	100	Sewing speed at fourth stitch starts
155	200 ~ 3200 (sti/min)	2000	100	Sewing speed at fifth stitch starts
156	400 ~ 3200 (sti/min)	3200	100	Sewing speed at fifth stitch before ends
157	400 ~ 3200 (sti/min)	3200	100	Sewing speed at fourth stitch before ends
158	400 ~ 3200 (sti/min)	3200	100	Sewing speed at third stitch before ends
159	400 ~ 3200 (sti/min)	2400	100	Sewing speed at second stitch before ends
164	ON / OFF	OFF	-	Trimming action prohibi ON: All trimmer action invalid OFF : Trimmer activate once matching sewing information
462	0 ~ 2	0	1	Expand the narrowed reference point 0: Center of the sewing frame (origin) 1: sewing start point 2: pattern center point
472	1 ~ 17	6	1	Two-stage presser setting: Set the height of the secondary presser foot in mm.
500	ON/OFF	1	-	Bottom thread clamp function setting ON: valid OFF: Invalid
566	ON/OFF	OFF	-	Bottom thread clamp device installation checking ON: The bottom thread clamping device is installed OFF: The bottom thread clamping device is not installed. [note] Do not select OFF when installing the bobbin thread clamp. It is easy to cause damage to the device.
962	ON/OFF	OFF	-	Broken thread dection ON: effective OFF: Invalid
964	ON/OFF	OFF	-	Auto run ON: effective OFF: Invalid
965	ON/OFF	OFF	-	Manual threader open ON: effective OFF: Invalid
966	0 ~ 2	2	1	Wiping method: 0: Invalid 1: Electronic 2: Pneumatic.
992	0 ~ 1	0	1	Frame shifting method 0: Move to the seam point after sewing is completed 1: Move to the specified point after sewing is completed
1000	0 ~ 1	0	1	Professional setting 0: invalid 1: valid

Basic Setting 2

1. Basic setting 2 interface

Click the enter button to enter basic setting 2 interface (as shown in figure).

2. Basic function 2 function description

(1) Restore super password

If super password forgot, you may recover super password as default password. Using this feature requires password from factory to get recovery permissions.

(2) Time and date setting

Set current time and date.

(3) Upper computer parameter setting

Press upper computer button to enter upper computer parameter setting interface.

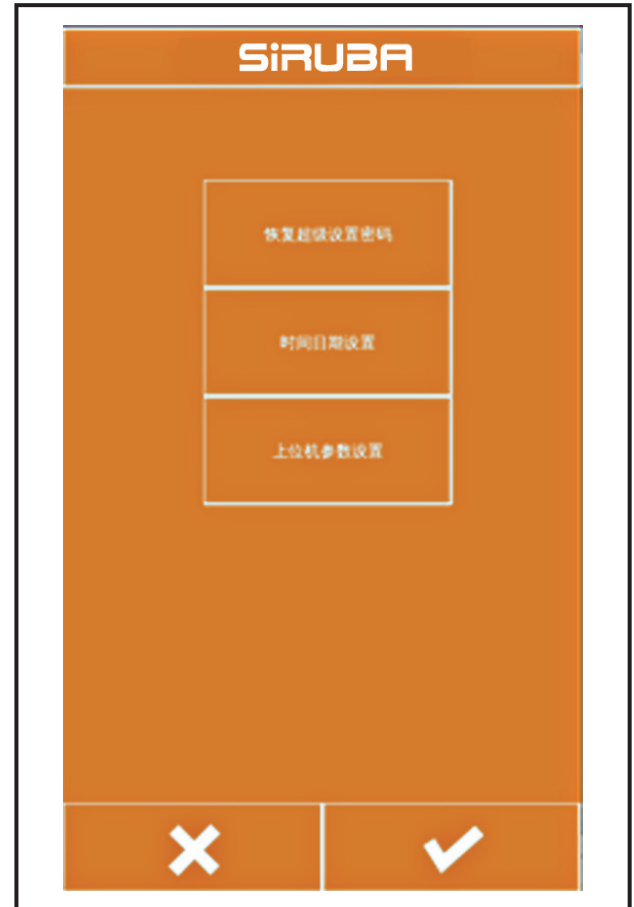

- ① Beep: ON: Use the beep, OFF: Turn off the beep.
- ② Prompt tone as default tone: ON: Prompt tone uses the unified default tone, and the OFF: Prompt tone does not use the unified default tone.
- ③ Prompt tone type: Select the type of default tone.
- ④ Stitch display: ON: The stitch point is displayed in all states in the pattern; OFF: The stitch point is displayed when the stitch point is operated in the pattern.
- ⑤ Power type: Select pneumatic or electric depending on the type of machine power.

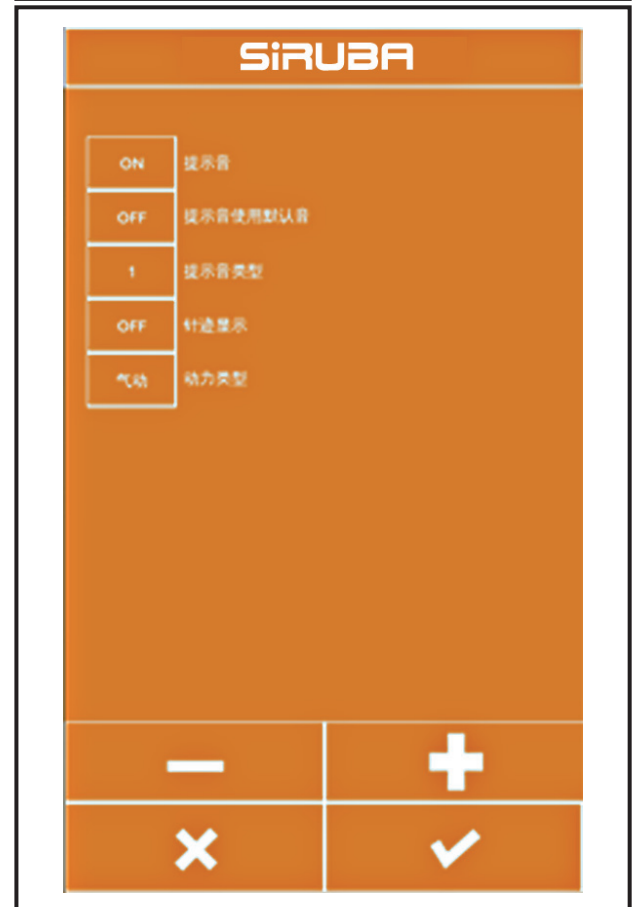

Advanced Setting

Advanced Setting Interface

Click the blank space behind the password to enter the password. After entering the password, click enter button to enter advanced settings interface (as shown in figure). Password setting button can change advanced setting password. Parameter setting button may adjust some advanced parameters. Upper computer upgrade button can update panel program. Lower computer upgrade button can upgrade control board program. Restore factory mode button restore all the setting to original factory setting. Original position button can adjust original position.



Advanced Parameters Setting

Click parameter setting button to enter advanced parameter setting (as shown in the figure)

- (1) Language Selection: Set Chinese/ English
- (2) Template Status: OFF: Do not use the template auto-sensing function; ON: Use the model auto-sensing function.
- (3) Template Checking: Preset mode as OFF. If set to ON, the template will leave an error when leaving the template sensor.
- (4) Template position sensor: Preset setting is OFF. If it is set to ON, template leaves the template sensor and the machine does not work.
- (5) Machine head memory: Memory setting should set as ON
- (6) Trimmer angle adjust: Negative values are advanced and positive values are delayed (-60 to 30).
- (7) Fabric feeding time adjustment: Negative value is advanced, positive value is delay (-60 to 30).
- (8) Broken thread detection
Needle sensitivity setting for broken thread checking.
- (9) Empty feed speed: Empty feed speed level (1-10), the larger the value, the faster.
- (10) Needle angle adjustment: Set the spindle stop angle.

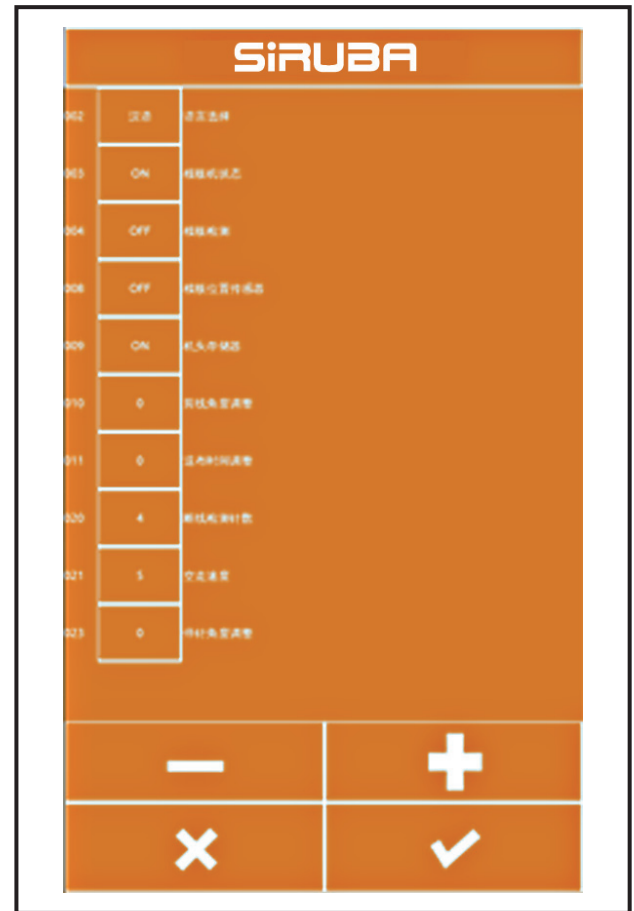

Upper Computer Upgrade

This program can upgrade upper computer (panel) through the USB flash drive. Before upgrading, you need to copy the new version of the program panel file and qm folder to the USB main page, then insert the USB into the panel, and then set the parameters --- >Advanced Settings--->Upper computer upgrades to upgrade the panel program. After the upgrade is successful, the message "Success, please restart" will appear, restart.

Lower Computer Upgrade

This program can upgrade the lower computer (control board) through the USB flash drive. Before upgrading, you need to copy the new version of the program nc.bin file to the USB main page, then insert the USB into the panel, and then pass the parameter setting ---> advanced Settings ---> lower machine upgrade to upgrade the control board program, after the upgrade is successful, there will be a "success, please restart" prompt, restart.

Super Setting

Super Setting Interface

Super setting interface as shown in the figure. It can only operate by manufacturer. Generally, the parameters in the super setting need to be set before leaving the factory.



Super parameter setting

Click the parameter setting button to enter the parameter setting interface of the super parameter, as shown in the figure.

- (1) Machine type: Select the appropriate model according to the machine type.
- (2) Display style: Generally choose default style.
- (3) Sewing speed limit value: Set the maximum sewing speed. After setting, the sewing speed will not exceed this value.



Installment Setting

Press the installment button to enter the installment payment interface. To enter the installment payment interface, you need to enter the password to proceed to the next step. For the password, please contact to manufacturer. After entering the password, you can set the panel ID number. After setting ID number machine cannot be sewn. Enter the installment password in the advanced settings to start sewing. Please contact the factory for the installment payment password.

Assistance Tool

Press assistance tool button to enter assistance tool interface as shown in the figure.



Template ID

This function is used to define the template. The template has a wireless identification card. Each card has an ID number which corresponds to the P pattern number in the panel. When a new wireless identification card template is created or the template ID is changed. The wireless identification card is placed on the template sensor, and then the template ID number is entered in the template ID editing block of the assisting tool interface, and the "write" is clicked after the input is completed. The button can be used to write the template ID number to the wireless identification card, and the completion of the writing will prompt the success.

Changing Startup Image

If you want to change the image displayed when the panel is started, you can send us the image you want to display. Then we will change the image to the file in the specified format and send it to you. You will put the modified image file on the USB flash drive. Insert the USB flash drive into the panel and click the "Change" button to change the startup image. The change will complete the prompt.

Kernel Upgrade

When you need to upgrade the kernel, we will provide you with the conprog.bin file. You can put this file into the USB flash drive and insert the USB flash drive into the panel. After the panel recognizes the USB flash drive, you can click on the kernel upgrade. The button is upgraded. After the upgrade is completed, the upgrade will be prompted.

Tones upgrade

When you need to upgrade the button prompt tone, we will provide you with the wxaudio folder. You can put this folder into the USB flash drive and insert the USB flash drive into the panel. After the panel recognizes the USB flash drive, you can click "The prompt tone upgrade button will be upgraded. After the upgrade is completed, the upgrade will be prompted.

Counter

Press the counter button to enter the counter interface as shown on the right. The sewing counter and the stitch counter mode can be set to set the counter current value and maximum value.

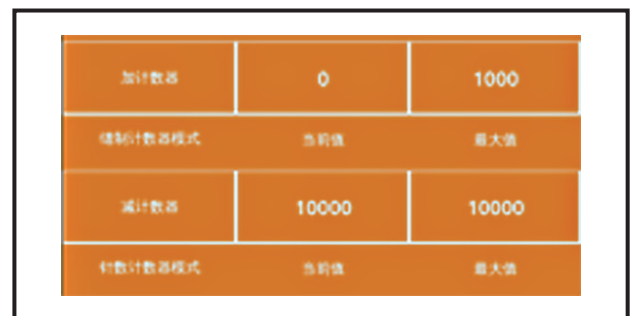

About

Press About button to enter the copyright information inquiry interface, enter the password to view the copyright information.

APPENDIX 1 ERROR TABLE

In the event of a machine failure, the operator panel will display an error code.

Please follow the troubleshooting methods in the table below to troubleshoot.

Error code	Description
10	While emergency stop button is pressed. press RESET button to eliminate error.
11	While pause switch is pressed. Press RESET button to eliminate error. Press RESET button and move the presser foot to continue sewing.
12	While pause switch is pressed. Press RESET button to eliminate error, step the pedal to the 2nd gear and check the origin.
15	While power is connected emergency button is pressed, but the emergency stop switch is defective. Turn off the power and check the plug of the motherboard socket P9 .
16	Poor contact in the emergency stop switch when the power is turned on. Turn off the power and check the plug of the motherboard socket P9 .
25	When the power is turned on, the foot pedal switch is stepped on the second gear position.(When the 2 pedal is controller, pedal is start switch) Turn off the power and check the foot pedal switch.
35	When electric power is stepped on the foot pedal switch position of the first gear. (When the 2- foot pedal switch is pressed, the power is turned off) and the foot pedal switch is confirmed.
50	After the power was turned on, the sewing machine head was found dumped. Turn off the power and lift the sewing machine head. Check the plug of the motherboard socket P14 .
51	The sewing machine head was found to be dumped during the sewing machine start-up process. Turn off the power and check the plug of the motherboard socket P14 .
55	When the power was turned on, the sewing machine head was found dumped. Turn off the power and lift the sewing machine head. Turn off the power and check the plug of the motherboard socket P14 .
65	When the power is turned on, operation panel button is being pressed, or the keys are not in good condition. Turn off the power and check the operation panel keys.
100	After “GREASEUP” notification appears, if no grease is added (do not perform the cleaning operation). Add the grease and then perform the action of clearing the work.
111	Incorrect stopping position ---Turn off the power supply and check if the thread trimming device or the sewing machine motor is abnormal.
121	Trimming cannot be completed. Turn off the power and check if the blade of the fixed knife or moving knife is scratched or damaged.
130	Main motor failure --- spindle motor failure, or spindle motor controller failure.
131	Poor contact in the sync display. Turn off the power and check that the plug of the motor main board's P11 is in good condition.
132	Sewing machine motor is rotating abnormal and cut off the power. Check the plug of the motor main board P11 whether in good condition.
133	The sewing main motor stops at a bad position. Turn off the power and check that the plug of the motor main board's P11 is in good condition.
150	The main motor of the sewing machine is abnormally warmed up or the temperature sensor is not working properly. Turn off the power and check the condition of the sewing machine motor. (If the sewing data is stitched (short cycle) with the number of short stitches (15stitches) repeatedly , the upper shaft motor may overheats, and [E150] may occur.)
200	The origin is not found in the X direction --- X motor failure, or Y origin sensor failure
201	The X pulse motor stops abnormally. Turn off the power and check if there is any abnormality in the X feed direction .
203	X motor over current --- X motor failure, or X motor control board failure
204	During the sewing process, the X pulse motor stops abnormally. Turn off the power and check if there is any abnormality in the X feed direction .
205	The X pulse motor stops abnormally during the movement to the sewing start position .Turn off the power and check if there is any abnormality in the X feed direction .
206	During the test transfer, the X pulse motor stops abnormally. Turn off the power and check if there is any abnormality in the X feed direction .
207	Unable to detect X motor motion --- Y motor failure, or X motor encoder failure, or X motor control board failure
208	X motor out of control --- X motor encoder failure, or X motor control board failure

210	Y direction cannot find the origin - Y motor failure, or Y origin sensor failure
211	The Y pulse motor stops abnormally. Turn off the power and check if there is an abnormality in the Y feed direction.
214	During the sewing process, the Y pulse motor stops abnormally. Turn off the power and check if there is an abnormality in the Y feed direction.
215	The Y pulse motor stops abnormally during the movement to the sewing start position. Turn off the power and check if there is an abnormality in the Y feed direction.
216	During the test transfer, the Y pulse motor stops abnormally. Turn off the power and check if there is an abnormality in the Y feed direction .
217	Unable to detect Y motor motion ---Y motor fault, or Y motor encoder fault, or Y motor control board fault
218	Y motor out of control ---Y motor encoder failure, or Y motor control board failure
300	The trimming motor can't find the origin --- trimming motor fault, or the trimming motor encoder is faulty.
301	Cannot detect the rise and fall of the presser foot /button clamp. Turn off the power and check if there is any abnormality in the up and down direction of the presser foot /button clamp.
303	Trimming motor overcurrent --- trimming motor failure, or trimming motor control board failure
307	Unable to detect electric motion of trimming motor --- trimming motor fault, or trimming motor encoder fault, or trimming motor control board fault
308	The trimming motor is out of control ---The trimming motor encoder is faulty, or the trimming motor control board is faulty.
320	Thread clamp motor cannot find the origin – thread clamp motor faulty, or thread clamp motor encoder fault
321	Thread clamp motor over current --- Thread clamp motor failure, or Thread clamp motor control board failure
323	Cannot detect the movement of the thread clamp motor electrical motor failure ---thread clamp, thread clamp motor encoder, the motor control board failure
324	Thread clamp motor is out of control --- Thread clamp motor encoder fault, or the Thread clamp motor control board is faulty.
400	When the power is connected, the connection communication error between the motherboard and the control board is detected . Turn off the power and check that the socket P1 of the power board main board and the socket P3 of the motor main board are in good condition.
401	When the power is turned on, link communication error between the motherboard and the motor motherboard is detected. Turn off the power and check that the socket P5 of the motherboard and the socket P2 of the motor main board are in good condition.
410	Communication error between the motherboard and the control board is detected . Turn off the power and plug it in again.
411	Communication error detected between the motherboard and the motor board. Turn off the power and plugs it in again.
420	The storage tool is not inserted. Press RESET button to eliminate errors.
421	The data content is incorrect and cannot be used, or there is no data. Press RESET button to eliminate errors. Confirm whether the data of the model serial number is stored in the storage.
422	An error occurred while reading the storage tool information. Press RESET button to eliminate errors. Confirm the data in the storage tool.
424	There is not enough space in the storage tool. Press RESET button to eliminate errors. Use other storage.
425	An error occurred while writing to the storage tool. Press RESET button to eliminate errors. Please use the specified storage. Check if writing is prohibited or if there is enough space.
427	The style registered in the loop program is deleted. Press RESET button to eliminate errors. Re-register the loop program and add the style.
428	The style set in the program is deleted. Press RESET button to eliminate errors. Reset the program and add a pattern.
430	Data cannot be backed up to the motherboard. Turn off the power and reconnect the power.
440	The board data storage is abnormal. Turn off the power and reconnect the power.
450	The model selection information cannot be read from the head storage device. Turn off the power and check that the plug of the power supply motor main board P16 is in good condition.
451	Data cannot be stored in the head memory. Turn off the power and reconnect the power.
452	Unable to connect to the head storage unit. Turn off the power and check that the plug of the P16 of the motherboard is in good condition.
480	Template position sensor Abnormal
500	After making the enlarged setting, the sewing data exceeds the area where sewing is possible. Press RESET button to eliminate errors. Set the magnification or sewing area again.

502	After making the enlarged setting, the data pitch exceeds the maximum pitch of 12.7 mm . Press RESET button to eliminate errors. Set the magnification again.
510	The program data is abnormal. Press RESET button to eliminate errors. Re-read the program data from the storage tool or re-load the program data.
511	The completion code cannot be entered into the program data. Press RESET button to eliminate errors. Redo the program data of the completion code, or change the serial number of the reader.
512	Exceed the number of stitches that can be used. Press RESET button to eliminate errors. Change the serial number of the reader.
581	The memory switch folder could not be read correctly. Model before copying and the model after copying are incorrect. (438F data possibility reading to 430F) Press RESET button to eliminate errors. Please read the information of the same model.
582	The versions of the memory switches are inconsistent. Press RESET button to eliminate errors. Please read the same version of the data.
583	The versions of the parameters are inconsistent. Press RESET button to eliminate errors. Please read the same version of the data.
600	Thread breaks occurred. Press RESET button to eliminate errors. After the press KEY_STEP_BACK keys to move the presser foot and you may continue sewing.
690	Intermediate pressure foot motor cannot find the origin ---the intermediate pressure foot motor is faulty, or the medium-pressure foot motor encoder is faulty.
691	Bottom thread clamping motor stops abnormally. Check whether the upper thread remaining length. Turn off the power and remove the flying velvet at the bottom of the needle plate. Check if the plugs of the sockets P20 and P4 of the motherboard board are in good condition.
693	Intermediate presser foot motor voltage over current --- intermediate pressure foot motor failure, or intermediate pressure foot motor control board failure
697	Cannot detect the movement of the presser foot --- electric motor in motor failure presser, the presser foot or motor encoder failure, the motor control board or failure presser foot
698	Intermediate presser foot motor out of control --- Medium presser foot motor encoder failure, or medium presser foot motor control board failure
700	The power supply voltage has risen abnormally. Turn off the power and check the input voltage.
701	The main motor drive voltage of the sewing machine has risen abnormally. Turn off the power and confirm the voltage
705	The power supply voltage drops abnormally. Turn off the power and check the input voltage.
710	The sewing main motor detects an abnormal current. Turn off the power and check if the sewing machine is abnormal.
711	The pulse motor detects an abnormal current. Turn off the power and check if the presser /button clamp is operating abnormally.
720	The nose cannot be lowered
721	The nose cannot rise
820	Pattern line
821	Pattern no end code
822	Pattern no stop code
830	Pattern data overflow
850	CAN current response error
901	X motor pulse error (internal error)
902	Y motor pulse error (internal error)
903	Trimming motor pulse error (internal error)
904	Intermediate presser motor pulse error (internal error)
905	Thread clamp motor pulse error (internal error)
906	internal error
911	internal error
912	internal error
913	internal error
914	internal error

中文

中文

一般安全聲明

由於縫製作業的具體情況，有時不得不靠近機器轉動的零部件進行操作而有可能接觸到轉動零部件，因此實際操作機器的操作員和維修保養的維修人員，必須在事前仔細閱讀有關安全的注意事項，充分理解內容之後再進行操作。此有關安全的注意事項中記述的內容有的不是使用者購買的商品規格的內容。

另外，為了能讓用戶充分地理解使用說明書以及產品的警告標籤，特將警告表示分為如下種類。請充分瞭解這些內容，並遵守指示的要求。

經理及主管有責任讓他們的同事在操作前完全理解。

沒有遵守本手冊中列出的說明可能導致嚴重傷害甚至死亡，以及財產損失。

警告圖示表示和指示標籤的說明

 <p>高壓電危險 DANGER 注意：關閉電源10分鐘後再打開箱蓋 TO OPEN THE COVER TURN OFF POWER SUPPLY AND WAIT 10 MINUTES BEFORE OPENING.</p>	<p>高壓部位 務必關閉電源 10 分鐘後 始打開電控箱蓋子</p>	 <p>Be careful of its movement. 移動快速 敬請小心</p>	<p>高速運動部位 謹防工傷事故</p>
 <p>CAUTION 機械作動部份請注意 保護裝置 穿線、換線、調整、清潔 時請注意關閉電源。 Moving parts may cause injury. Operate with safety devices. Turn off main switch before threading, changing bobbin and needle, cleaning etc.</p>	<p>高速運動部位 謹防工傷事故</p>		<p>高速運動部位 謹防工傷事故</p>

警告圖標表示		警告圖標表示	
	<p>有接觸轉動部，造成受傷的危險。</p>		<p>作業時拿縫紉機的話，有讓手受傷的危險。</p>
	<p>有接觸高電壓部，造成觸電的危險。</p>		<p>有捲入皮帶，造成受傷的危險。</p>
	<p>有接觸高溫部，造成燙傷的危險。</p>		<p>觸摸了鈕扣傳送器，有受傷的危險。</p>
	<p>如果直接目視鐳射的話，有傷害眼睛的危險。</p>	指示標籤	
	<p>有頭部接觸到縫紉機的危險。</p>		<p>指示正確的轉動方向。</p>
			<p>指示地線的連接。</p>

有關安全的注意事項

危險

事故：是指給與人身以及財產帶來損害。

需要打開電氣箱時，為了防止觸電事故，請關閉電源，經過 5 分鐘以上的時間之後再打開電氣箱蓋。

注意

1. 基本注意事項

- (1) 使用之前，請您一定要閱讀使用說明書以及附屬的所有說明資料。另外，請您妥善保管本使用說明書，以便隨時可以立即查閱。
- (2) 本注意事項中有部分內容可能不是您所購買的機器規格的内容。
- (3) 為了防止斷針造成的事故，請戴上安全防護眼鏡進行操作。
- (4) 使用心臟起搏器的人，請一定要與專門醫生諮詢之後再使用。

2. 安全裝置、警告標籤

- (1) 為了防止由於沒有安裝安全裝置而造成的事故，操作本機器時，請確認安全裝置是否正確地安裝到規定位置之後再進行操作。
- (2) 為了防止人身事故，卸下了安全裝置後，請一定再安裝到原來的的位置，並確認功能是否正常。
- (3) 為了防止人身事故，請把警告標籤時常地粘貼到可以明顯看到的機器上。如果脫落或發生汙損，請立即更換成新的標籤。

3. 用途、改裝

- (1) 為了防止人身事故，請不要將本機器使用於本來的用途和使用說明書規定的使用方法以外的用處。
- (2) 請不要改裝機器。任何未經授權的規範更改都不在保修範圍內。
- (3) 本公司對因改裝或更改的機器造成的損壞，傷害或死亡不承擔任何責任 / 義務。

4. 教育培訓

- (1) 工廠經理 / 主管有義務為操作員和維修技師提供教育和培訓。良好的教育 / 培訓計劃不僅可以避免人身傷害，還可以防止財產損失。
- (2) 只讓具有訓練有素的操作員操作機器。
- (3) 只讓具有經過認證的技術人員為機器提供服務。

5. 必須關閉電源的事項

關閉電源：按 EMG 停止（如果有），是指關閉電源開關之後，並且把電源插頭從電源插座上拔下來。

- (1) 當確認了異常、故障後以及停電時，按 EMG 停止（如果有），請立即關閉電源。
- (2) 為了防止因機器突然啟動造成的事故，在如下情況時，請一定關閉電源之後再進行操作。
- (3) 清潔或檢查機器時，請確保機器在關閉電源後完全停止。
- (4) 執行維修（即更改調整任何組件）時，請確保電源已關閉且機器完全停止。

6. 為了防止觸電、漏電、火災事故，拔電源插頭時，一定要手持插頭拔電線，而不能拉著電線拔。
7. 只要機器在工作之間無人看管，請關閉電源。
8. 如果出現電源故障或停電，請關閉電源以避免損壞或發生事故。
9. 不遵守上述指示可能會對操作員造成嚴重傷害或死亡。

在各使用階段的注意事項

1. 搬運

- (1) 抬起縫紉機移動時，請一定根據機器的重量採用確保安全的方法進行搬運。另外，有關機器重量，請確認使用說明書的說明。
- (2) 抬起縫紉機移動時，請採取確保安全的措施防止翻倒、掉落。
- (3) 為了防止不可預想的事故、掉落事故、機器損壞，請不要再次包裝已經開箱的機器進行搬運。

2. 開箱

- (1) 開箱時請按照從上方開始的順序進行開箱。木框包裝時，請一定要小心不要被釘子紮破。請把釘子從木板上拔下來。
- (2) 取出機器時，請一定首先確認機器的重心位置然後小心地取出。

3. 安裝：

3A. 機台、台腳

- (1) 請一定使用純正的機台、台腳。不得以使用非純正的零件時，請一定使用可以充分承受機器重量、運轉時的反作用力的機台、台腳。
- (2) 在台腳上安裝腳輪時，請使用具有充分強度的帶鎖定裝置的腳輪，操作機器時、維修保養、檢查、修理時進行鎖定不要機器晃動。

3B. 電纜、電線

- (1) 電纜和電線必須符合規範和要求，請不要向電纜施加過大的力量。
- (2) 電纜和電線應無彎曲或額外的力。在電纜 / 電線和運動部件之間保留至少 30mm 的自由空間。
- (3) 接線時請不要進行分岔佈線。
- (4) 請一定牢固地固定連接器。另外，拔連接器時，請一定手持連接器拔線。

3C. 接地

- (1) 接地是必要的，請具有電氣專門知識的人安裝電源插頭。
- (2) 檢查並確保在操作前確保地線接地。

3D. 馬達

- (1) 電動機必須符合規範和要求。
- (2) 如果馬達傳動裝置中有皮帶，請一定選用安裝有防止捲入功能的皮帶護罩的離合馬達。

4. 操作前

- (1) 接通電源之前，請一定確認連接器、電纜等確實沒有損傷、脫落、鬆動。
- (2) 請確認皮帶輪的轉動方向是否與箭頭標記一致。
- (3) 請一定鎖定腳輪，帶有調節器時，請調節台腳把腳固定好。
- (4) 保持工作區域遠離障礙物。

5. 操作中

- (1) 操作機器時，請注意不要讓手指、頭髮、衣服靠近皮帶輪、手輪、馬達等轉動部位，也不要將物品放到上面。
- (2) 機器設計為高速運轉。始終將手遠離移動區域。在機器完全停止之前，請勿恢復工作循環。
- (3) 拆卸或重置機器時，請注意不要被機器或部件夾住。
- (4) 為避免突然啟動造成的事故，在對電機或皮帶進行維修時，請確保電源已關閉且機器完全停止。
- (5) 伺服電機在機器停止時靜音。務必關閉電源以避免突然啟動。
- (6) 始終保持電源櫃的風扇和氣道暢通無阻。

6. 加油

- (1) 按照手冊中的說明，請使用純正的機油和純正的潤滑脂向規定部位進行加油和塗抹潤滑脂。
- (2) 如果潤滑劑接觸到您的眼睛或身體，請立即將其清洗乾淨。如有必要，請諮詢醫療護理。
- (3) 為了防止腹瀉、嘔吐，如果誤飲了機油，請立即就醫治療。

7. 維修保養

- (1) 只允許經過認證的工程師 / 技術人員對機器進行維修，包括調整和維修。僅使用原裝零件進行更換。對於因維修或調整不當或使用正品以外的任何部件而導致的任何事故，本公司不承擔任何責任 / 義務。
- (2) 只允許經過認證的技術人員或授權工程師維修或維護電氣系統。
- (3) 當對氣缸等氣動部件進行維修時，首先斷開氣源並完全排出空氣，以避免突然啟動。
- (4) 調整更換後檢查所有螺釘和螺母是否固定好。
- (5) 需要定期清潔。清潔前確保電源已關閉且機器完全停止。
- (6) 如果機器功能不良或異常，請停止操作並關閉電源。請聯繫授權經銷商或我們，以獲得技術服務支持。
- (7) 當保險絲發生故障時，關閉電源，找出故障原因並對其進行解決，然後更換相同規格的新電源。
- (8) 定期檢查並清潔風扇通風道和電纜 / 接線。

8. 工作環境

- (1) 請在沒有高頻電焊機等強噪音源（電磁波）影響的環境下使用縫紉機。
- (2) 電源應處於良好可靠的狀態，額定電壓的波動應小於 10%。
- (3) 始終檢查氣壓和質量。如果電源不可靠，可能需要一些額外的設備。
- (4) 本機設計使用環境溫度 5°C ~35°C，相對濕度 35% ~85%。
- (5) 為保護電子元件和安全原因，當溫度急劇上升導致霜凍時，請斷開電源並等待其完全乾燥。
- (6) 出於安全原因，當發生雷鳴或雷電時，請停止操作並斷開電源。
- (7) 請勿在機器附近使用電視或收音機以免干擾。
- (8) 操作期間應用必要的保護。遵守當地政府制定的適用法規。
- (9) 對於包裝，潤滑劑和產品的處理，請遵守當地管理部門製定的適用法規。

概要說明	1
操作說明	5
快捷 (P) 花樣操作	22
組合 (C) 花樣操作	25
花樣圖案編輯	30
資訊功能	39
通訊功能	40
模式和參數設置	45
附錄 1 誤碼表	57

概要說明

概述

本系列工業縫紉機電腦控制系統，主軸電機採用具有世界先進水準的交流伺服控制技術驅動，具有力矩大、效率高、車速穩定和噪音低等特點。操作面板設計多樣化可滿足不同客戶的配套要求；系統採用德國式結構設計，安裝和維修方便快捷，系統控制軟體可通過遠端通訊升級，方便使用者不斷提高產品性能。

技術參數表

項目	機型	平縫花樣縫紉機（帶大旋梭）
1	線跡形式	單針平縫
2	最高縫紉速度	2,700rpm
3	縫紉尺寸（X×Y）	GSM-1310G 最大：130×100mm; GSM-2210G 最大：220×100mm
4	送布驅動方式	間歇送布（脈衝馬達驅動）
5	針距	0.05-12.7mm
6	針數	記憶體 500,000 針（※）
7	最大針數	20,000 針（1 個程式）
8	存儲可能縫紉的資料	記憶體：999（※）.U 盤：無限制
9	抬壓腳驅動方式	電磁規格：脈衝馬達驅動，空壓規格：空壓式
10	壓腳上升量	電磁規格：最大 25mm，空壓規格：最大 30mm
11	2 段壓腳	電磁規格：左右一體式壓腳，空壓規格：左右分離式壓腳
12	間歇壓腳上升量	22mm
13	間歇壓腳行程	2-4.5mm、4.5-10mm 或 0（出廠時 3mm）
14	使用的旋梭	半回轉 2 倍旋梭（標準旋梭另買）
15	扣線裝置	標準裝備
16	切線裝置	標準裝備
17	資料存儲方式	記憶體（快擦寫記憶體），CF 卡（32,64,128,256MB） [選購件]3.5 磁片 2HD/1.44MB.2DD
18	使用者程式數	50
19	迴圈程式數	9
20	馬達	AC 伺服馬達 550W
21	重量	頭部：約 88kg，操作盤：約 0.6kg 控制箱：14.2-16.2kg（根據電壓不同而不同）
22	電源	單相 100V/220V、3 相 200V/220V/380V/400V 400VA
23	空氣壓力	0.5Mpa 1.81/min

※ 最高縫製速度請根據縫製條件降低速度使用

安全使用注意事項

1. 作業環境

本控制裝置請不要在下述的環境使用：

- (1) 電源電壓
電壓的變動會超出定格電壓 $\pm 10\%$ 以上的場所。
電源容量無法確保在規定容量的場所。
- (2) 電波干擾
旁邊有會發射出強烈電波和磁場的電波發射器和高周波機器的場所。
- (3) 溫濕度
室溫在 $0^{\circ}\text{C} \sim 50^{\circ}\text{C}$ 之間的場所。
室外或日光會直接照射到的場所。
暖爐 (電熱器) 旁的場所。
相對濕度在 $5\% \sim 95\%$ (不凝露) 之間的場所。
- (4) 空氣
具有腐蝕性或多灰塵的場所。
容易發生氣爆或油爆的場所。
- (5) 振動
縫紉機放置的場所容易發生過度振動的話，把控制箱放置到別的地方。

2. 安裝

- (1) 控制箱
請遵照說明正確裝好
- (2) 附件
如要安裝其它附件時，請先關掉電源並拔掉電源插頭。
- (3) 電源線
請不要用重力去壓住電源線或過度的扭曲電源線。
請不要將電源線靠近轉動的部位，最少要離開 25mm 以上。
控制箱要接入電源前，請必再查看要接入的電源電壓是否與控制箱上標示的電壓相同及確定位置後，才可供應電源。如有接用電源變壓裝置的話，同樣的要檢查一下後才可供應電源。這時縫紉機上的按鈕式電源開關一定要放在 [OFF]。
- (4) 接地
為防止雜訊干擾及漏電而發生電擊事件，電源線上的接地線定要確實做好接地。
- (5) 附屬裝置
如要接用電氣方面的附屬裝置的話，請遵照指示的位置接好。
- (6) 拆卸
要卸下控制箱時，必須要先關掉電源並拔掉電源插頭。
在拔離電源插頭時不可只拉電源線，必須用手

拿住電源插頭拔出。

控制箱裡面有危險的高壓電，所以要打開控制箱蓋的話，需要先關掉電源後等候 5 分鐘以上才可打開控制箱蓋。

3. 保養、檢查和修理

修理和保養的作業，要請經過訓練的技術人員執行。

更換機針和梭子時，請務必關電。

請使用正廠的零件。

4. 其它的安全對策

縫紉機運轉中請不要去觸摸會轉動和會移動的部位 (特別是機針和皮帶附件) 等，並注意頭髮不要靠近它們，以免發生危險。

控制裝置不可摔落地，更不可在空隙間塞入其它物品。

請不要在拆掉各護蓋的情形下運作。

如本控制裝置有損傷或無法正常運作時，必要請有經驗的技術人員調整，或檢查修理，在故障還沒排除前請不要再去運轉它。

敬請各客戶們不要自行改造或變更本控制裝置。

5. 廢棄處理

請以一般產業廢棄物處理。

6. 警告示意和危險示意

錯誤的行為可能會發生危險，其程度如後述的標示區別說明。



警告

錯誤的行動可能會發生重傷或死亡。



注意

錯誤的行動可能會發生傷害或房屋或財產的損害。

標示符號的表示如下說明。

	請遵照指示內容作業。
	注意高壓電的危險。
	注意高溫。
	務必接上接地線。
	絕對不要執行。



警告！ 使用上的預防措施

1、當手要按開關 [ON] 時，腳定要離開腳踏板。



2、要離開工作崗位時，請務必關掉電源。



3、如要橫倒頭部或更換機針或穿麵線時，請務必關掉電源。

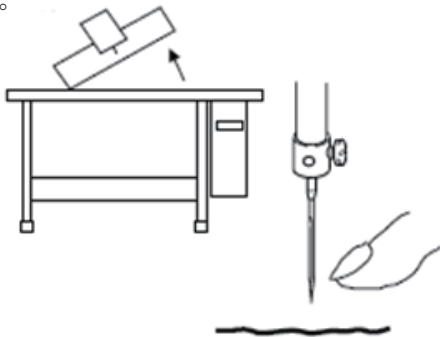

4、接地線要做好接地。

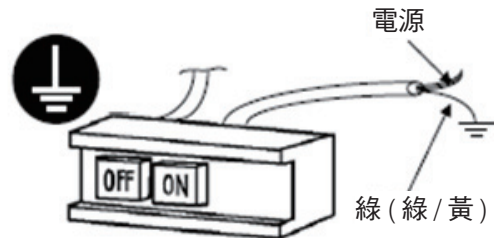

5、不要用家庭用多插孔式延長線。

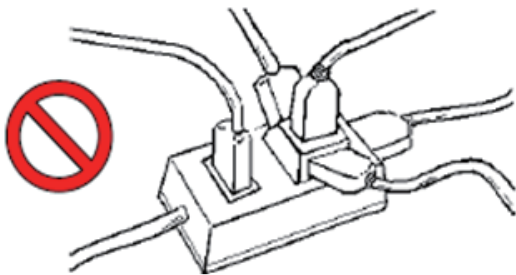

6、控制箱內部存有危險的高壓電，所以關掉電源後等候 5 分鐘才可打開控制箱蓋。

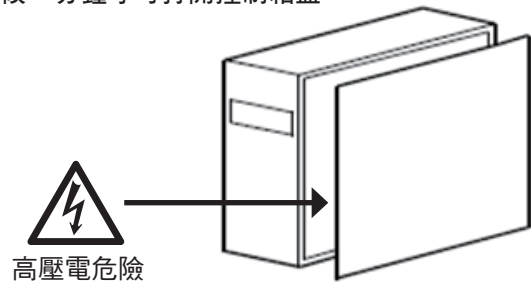

7、更換電機後，請務必參照本資料所示設置主軸電機安裝角度。

8、請遠離會產生高周波雜訊干擾的機器。

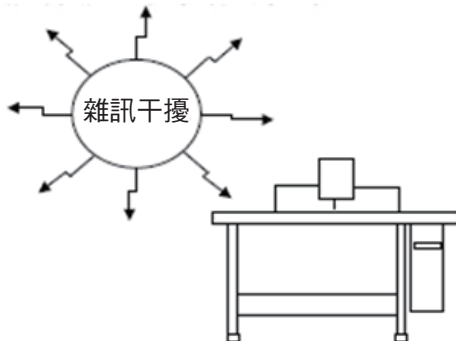

9、如利用外接信號插座接應用附屬裝置時，其連線長度請盡量越短越好，長線可能會導致誤動作，連線線請用隔離線纜。

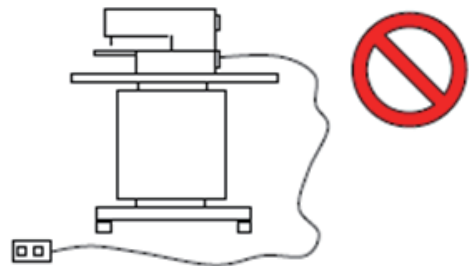

10、如保險絲燒斷時，請先把原因排除後再換相同容量的保險絲。

標準化

功能按鍵採用業界公認的圖形標識，圖形是國際化語言，各國使用者都可以識別。

操作方式

本系統觸控式螢幕操作面板採用了業界先進的觸摸操作技術，友好的介面以及便捷的操控都給用戶的日常使用帶來革新性的變化。使用者可以使用手指或者其他物體點觸螢幕，完成相應的操作。用戶在使用過程中應該注意避免使用尖銳的物體觸碰螢幕，以免對觸控式螢幕造成永久性損傷。

功能鍵包括準備鍵，資訊鍵，模式鍵以及通信鍵等。具體操作方法參照後面章節的說明。

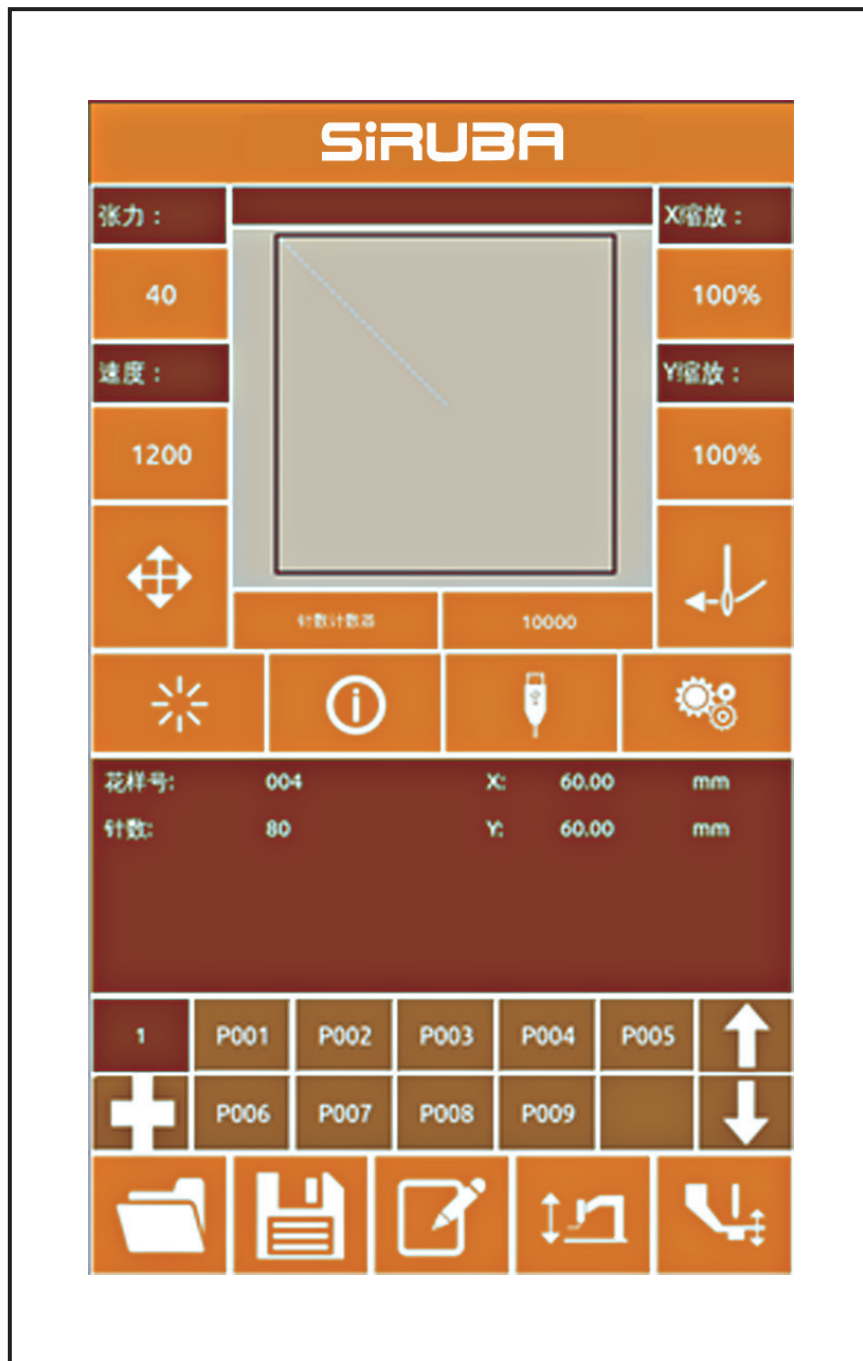

警告！ 用戶在使用過程中應該注意避免使用尖銳的物體觸碰螢幕，以免對觸控式螢幕造成永久性損傷。

操作說明

通用按鍵

在本系統的各介面上進行通用操作的按鍵如下：

序號	圖示	功能
1		確認鍵 → 輸入介面進入縫製介面 / 縫製介面退出至輸入介面
2		資訊鍵 → 查看版本資訊和穿線圖
3		通信鍵 → U 盤與面板通信，進行花樣或參數的相互拷貝
4		設置鍵 → 進入功能介面
5		花樣選擇鍵 → 打開花樣文件
6		登記鍵 → 登記花樣檔號碼
7		命名鍵 → 輸入花樣名
8		電動壓框抬落鍵 → 電動機型抬落壓框，氣動無效
9		中壓腳高度鍵 → 設置中壓腳高度
10		調整鍵 → 調整起縫點
11		穿線鍵 → 穿線
12		取消鍵 → 取消當前設定值 / 退出當前介面
13		確認鍵 → 保存當前設置值
14		試縫鍵 → 進入單步縫介面
15		繞線鍵 → 進入繞線狀態

基本操作

① 打開電源開關

打開電源之後，顯示出資料登錄介面。



② 選擇想縫製的圖案 No.

當前介面下會顯示出已選擇的圖案 No.，按下花樣選擇鍵  之後進入子功能表可以選擇圖案 No.。

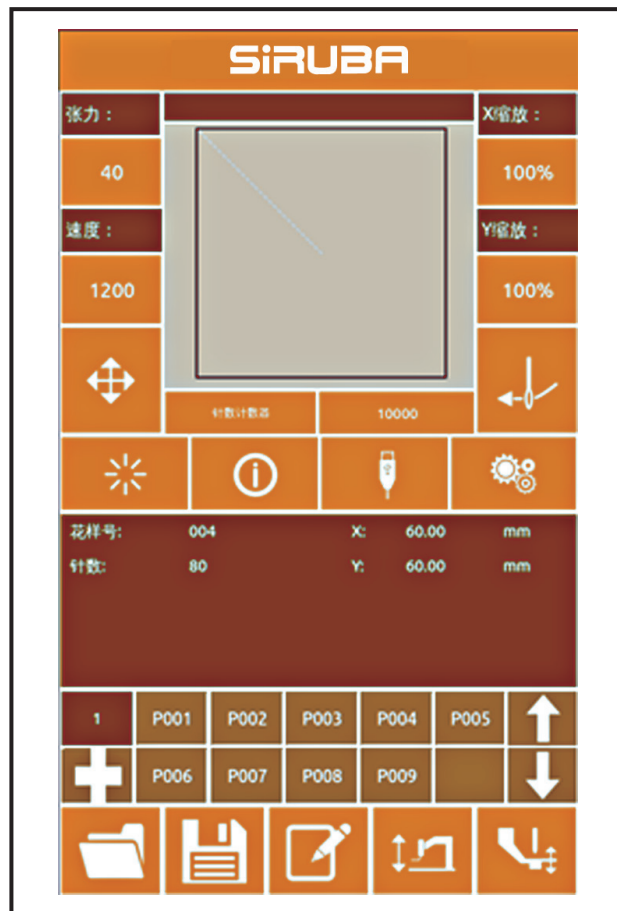
有關花樣選擇的操作，詳見【花樣選擇】一節。



③ 設定成可以縫製的狀態

按準備鍵  之後，該按鈕顏色加深  表示進入花樣確認介面，此時為可以縫製的狀態。

④ 開始縫製

把縫製品安放到壓腳部，踩踏板落下壓腳，縫紉機啟動，開始進行縫製。

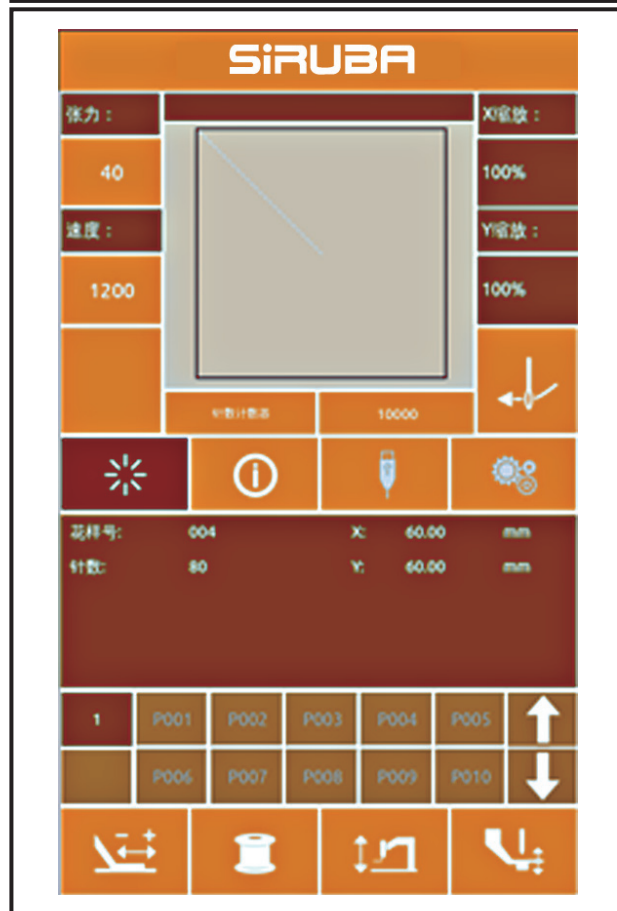

普通花樣操作

(1) 縫製資料登錄介面

資料登錄介面如右圖所示，詳細功能說明請見功能鍵說明表。

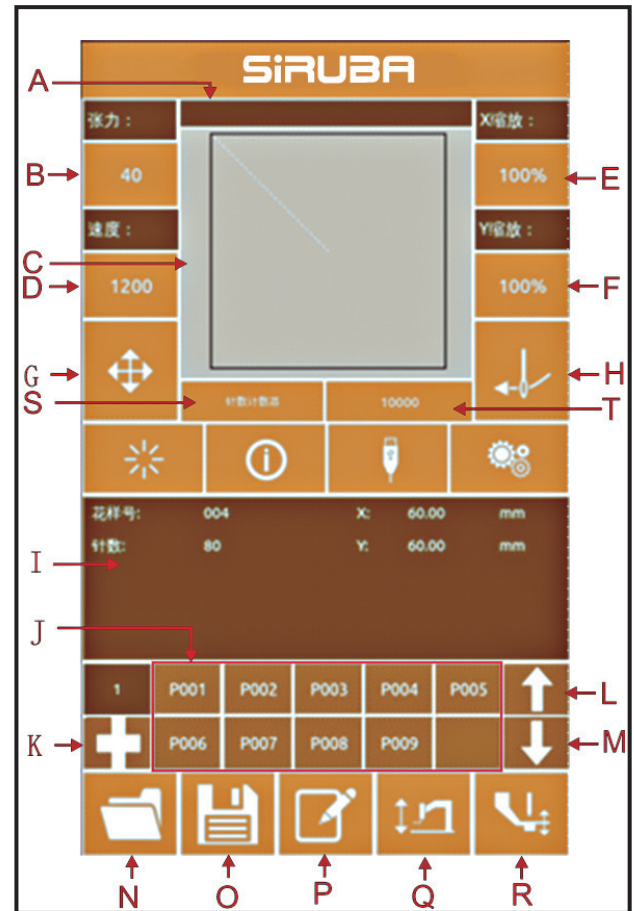

功能說明：

序號	功能
A	花樣名稱顯示區域
B	張力按鍵
C	花樣圖形顯示區域
D	速度按鍵
E	X 縮放率按鍵
F	Y 縮放率按鍵
G	調整起縫點按鍵
H	穿線按鍵
I	花樣資訊資訊顯示區域
J	P 花樣快捷按鍵區域
K	P 花樣登記按鍵
L	P 花樣上翻頁按鍵
M	P 花樣下翻頁按鍵
N	花樣選擇按鍵
O	花樣登記按鍵
P	花樣命名按鍵
Q	電動壓腳抬落壓框按鍵
R	中壓腳高度按鍵
S	計數器模式按鍵
T	計數值按鍵

(2) 縫製介面

按下  進入縫製介面如右圖所示。詳細功能說

明請見功能鍵說明表。

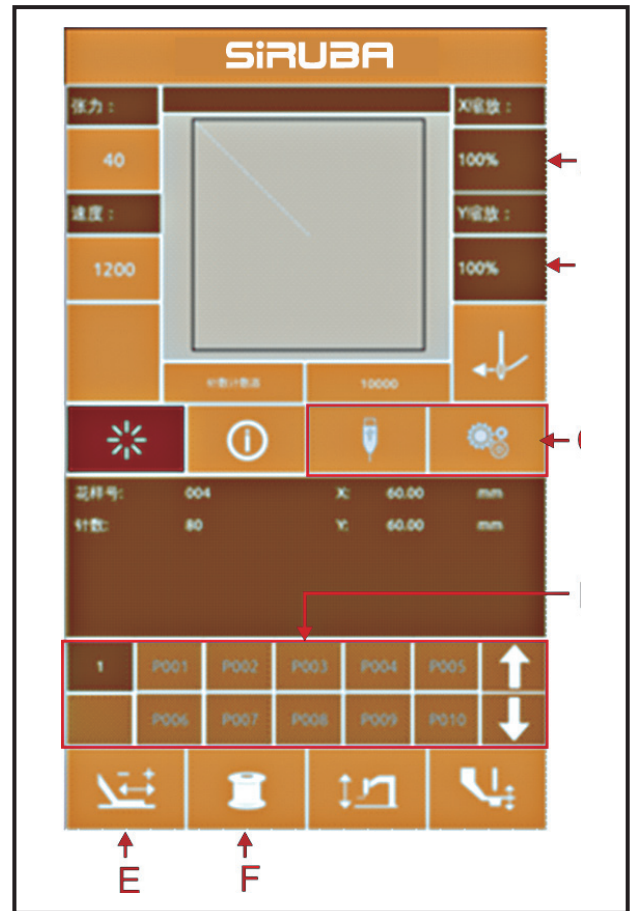

序號	功能
A	X 縮放率顯示
B	Y 縮放率顯示
C	不可操作按鍵
D	P 花樣區域不可操作
E	試縫按鍵
F	繞線按鍵
---	其他按鍵同輸入介面功能

花樣登記

最多可以登記普通花樣 999 個。按下  進入花樣

登記介面（如右圖所示）：

① 輸入花樣號

通過數位鍵可以選擇想要輸入的花樣號碼，花樣

號碼範圍必須為 201~999，如果輸入其他號碼會

顯示超出號碼範圍。

② 登記新花樣

確定花樣號碼後按下 ，之前顯示花樣資料會

複製到新登記花樣中，操作結束後返回到新登記

花樣資料登錄介面。

如果輸入號碼已被登記號碼會提示是否覆蓋已存

花樣。

按  按鍵後退出登記介面。



SIRUBA		
020		
7	8	9
4	5	6
1	2	3
0	▼ -	▲ +
✕		✓

花樣命名

按下  進入花樣命名介面（如右圖所示）。

A	刪除	逐個刪除輸入字元
B	右移	游標右移
C	左移	游標左移
D	清空	清空當前輸入的全部字元

選擇想要輸入的字元，按下  結束花樣命名操作。

通過移動游標可以確定該字元位置，刪除鍵可以消除該位置字元。

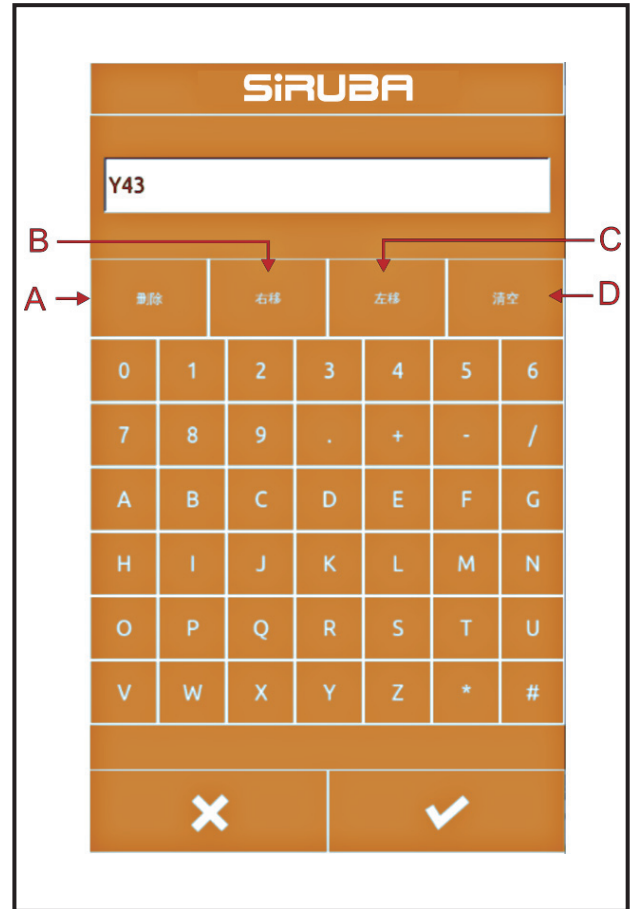

繞線

① 安裝梭芯

把梭芯插進繞線軸。如右圖所示。

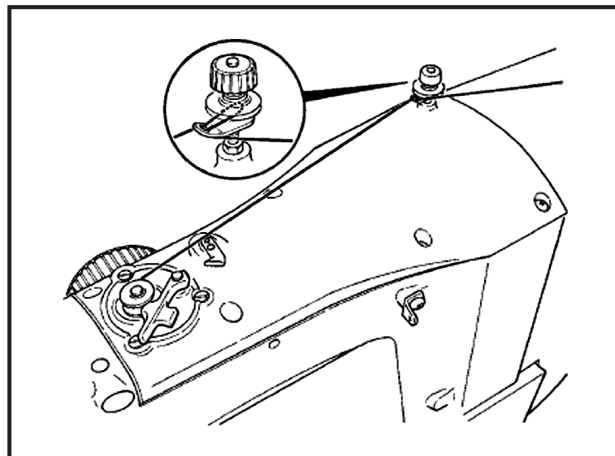

② 顯示底線繞線介面

在縫製介面上，按了繞線按鍵  之後，繞線介面被顯示出來（如右圖所示）。

③ 開始繞線

踩踏左踏板落壓腳後，踩踏啟動踏板開始繞線。

④ 停止縫紉機

繞線啟動後，再次踩踏啟動踏板則繞線停止轉動，

繞線停止後踩踏左踏板壓腳抬起返回縫製模式。

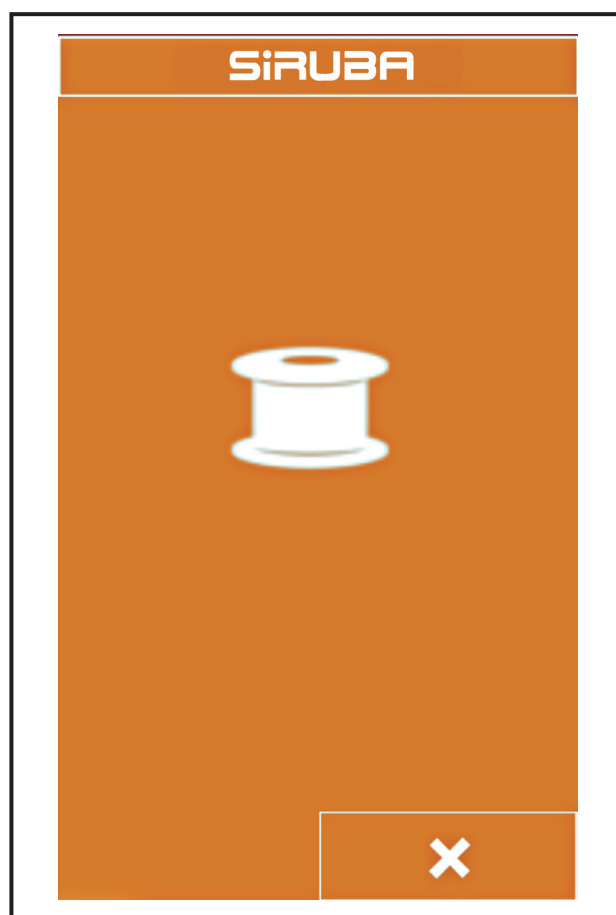

穿線

① 進入穿線狀態

在輸入介面或縫製介面按  鍵進入穿線狀態，

穿線按鍵變為紅色 ，畫面變化如圖所示，此

狀態下機器無法進行其他操作。

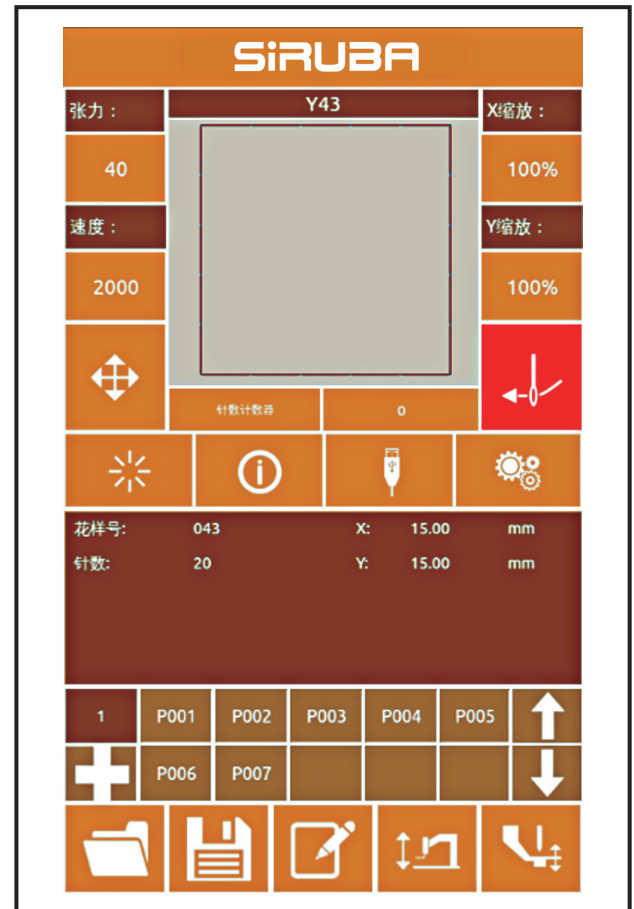

② 退出穿線模式

穿線結束後，再次按下  鍵，返回到輸入介面

或縫製介面。

花樣選擇

① 進入花樣選擇介面

資料登錄介面（如右圖 1 所示），點擊選擇按鍵 A 之後進入花樣選擇介面（圖 2）。

圖 2 資訊如下：

A	花樣名稱
B	花樣尺寸資訊
C	花樣圖形顯示
D	已登記花樣號碼
	花樣上翻頁
	花樣下翻頁
	花樣刪除

② 選擇花樣

花樣號碼區域 D 每頁可顯示 25 個花樣號碼；選中某個花樣號碼按鈕後，當前花樣圖形及資訊顯示在上方。花樣資訊包含花樣號碼、X 方向長度、Y 方向高度、花樣命名的字串（未命名的花樣不顯示字串）。

按下  完成花樣選擇操作。

③ 花樣刪除

選中某個花樣號碼按鈕，按下  鍵就會刪除掉該花樣。

注：花樣分為基礎花樣和普通花樣：基礎花樣為出廠花樣；普通花樣為用戶打版、複製或 U 盤導入的花樣，花樣可以被刪除和修改，但刪除掉的花樣將無法被找回，請謹慎操作。

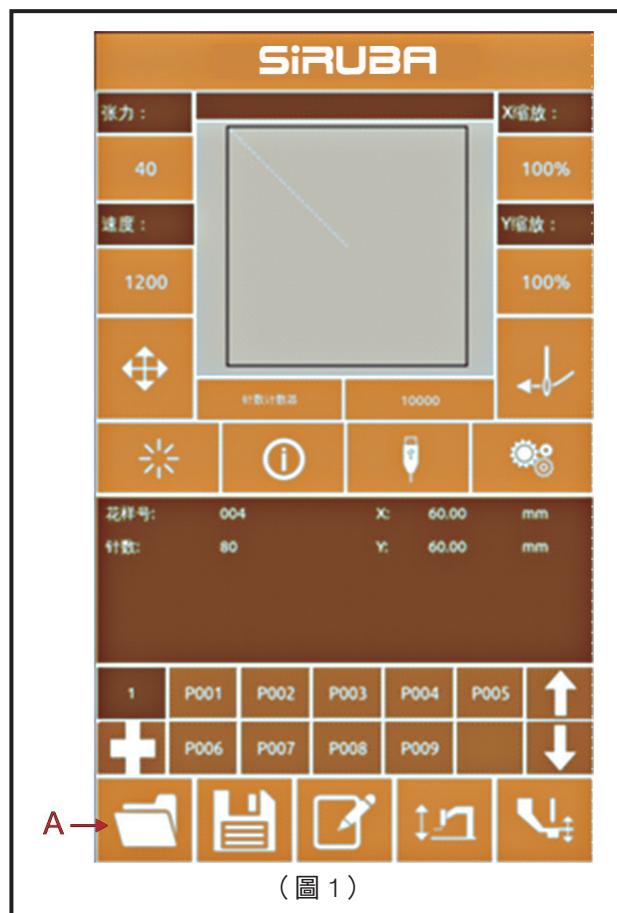

(圖 1)

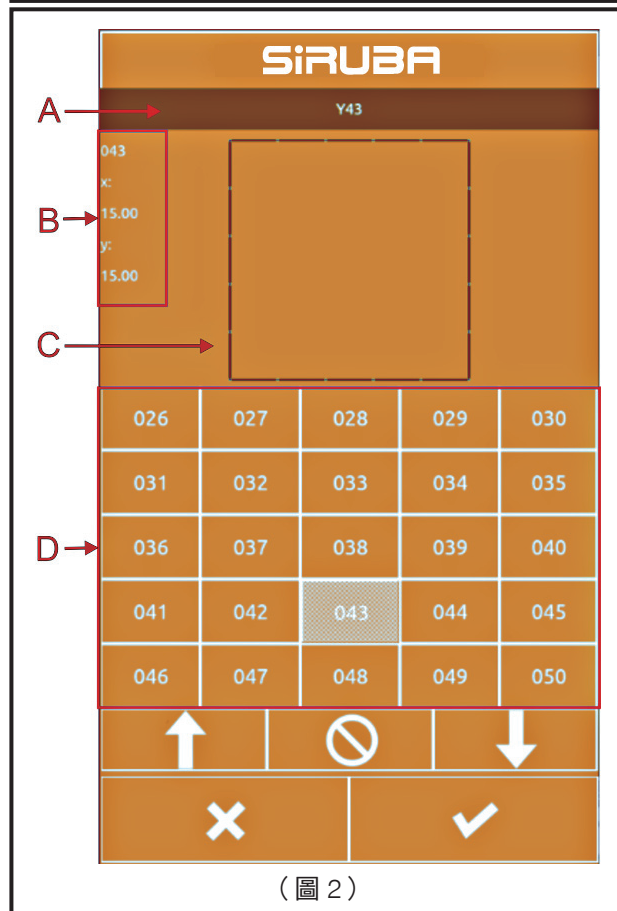

(圖 2)

縫紉數據設定

① 進入縫紉資料設定介面

在資料登錄介面下相應按下 A、B、C 可分別進入縮放率設置和速度限制設置介面。

	項目	輸入範圍	初始值
A	張力值	0~120	40
B	縫製速度	400~2500rpm (上限在超級設置參數中設置)	2000rpm
C	X 方向放大縮小率	1.0~400.0%	100.0%
D	Y 方向放大縮小率	1.0~400.0%	100.0%
E	中壓腳高度	0.0~7.0mm	2.0mm

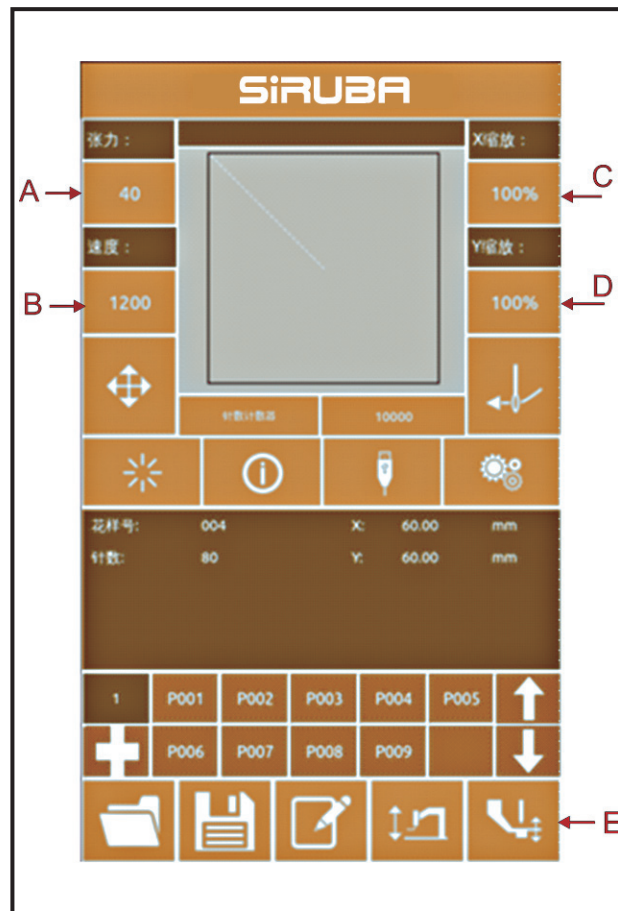

注：最高速度限制的在“超級設置→參數設置→3: 最大縫製速度”中限制。

② 縮放率設定

右圖為放大縮小率設定介面，介面上方為 X 方向設置，下方為 Y 方向設置。

A：X 方向縮放率顯示

B：X 方向實際長度值顯示

C：Y 方向縮放率顯示

D：Y 方向實際高度值顯示

通過數位鍵盤或 +、- 鍵輸入希望值，被輸入的數位插入到顯示數值的第一位，以前輸入的數字一位元一位元的累進，按下確定鍵  完成操作返回資料登錄介面。

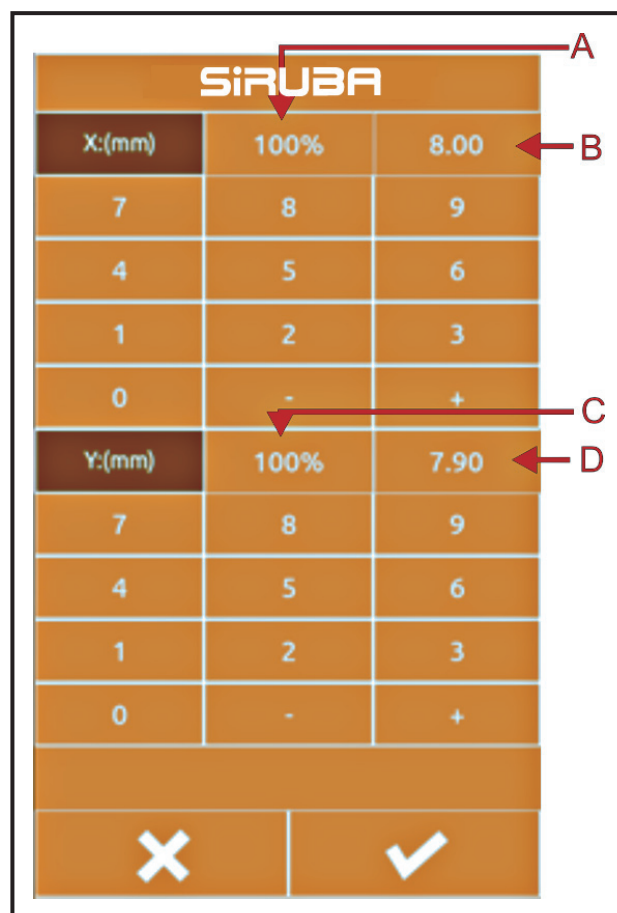

③ 速度值設定

操作同上

④ 中壓腳高度值設定

操作同上

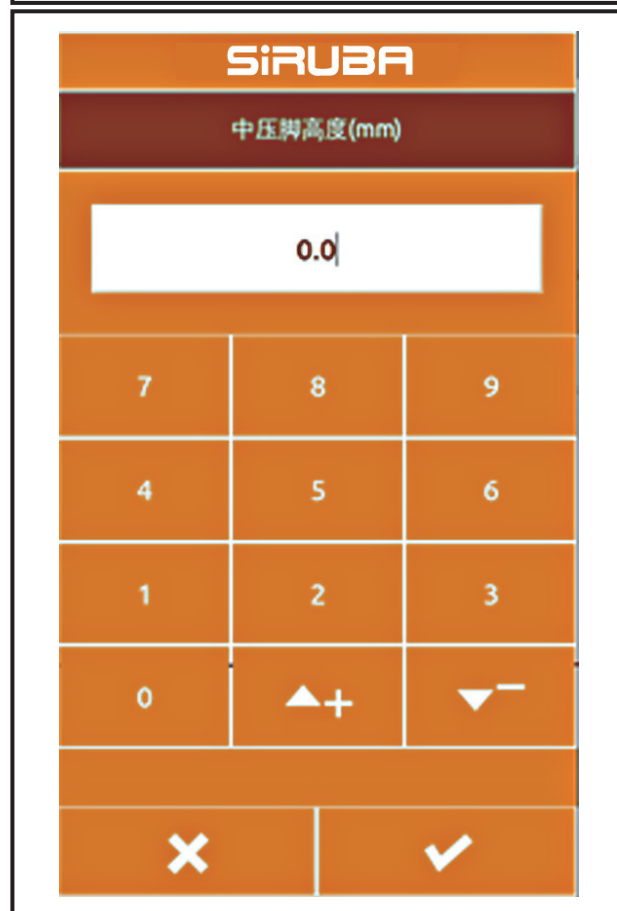





P 花樣登記

① 進入 P 花樣登記介面

在資料登錄介面下顯示普通花樣的情況下按下

 進入 P 花樣登記介面，如右圖。

② 輸入 P 花樣號碼

通過  ~  十數位鍵盤或 、 鍵輸入想要登記的號碼，如果輸入了已經登記的花樣號碼，會提示此號碼已被佔用，這種情況下使用者需重新輸入想要登記的號碼。

③ 選擇資料夾號碼

P 花樣號碼可以登記到 26 個資料夾裡，每個資料夾最多保存 10 個 P 花樣。資料夾選擇鍵 A 按鍵可以進行順序選擇。

④ 確定花樣號碼

按下確定鍵  之後完成 P 花樣登記操作，返回到 P 花樣資料登錄介面，如圖所示。

⑤ 刪除 P 花樣

選中 P 花樣號碼，按下刪除鍵 ，即可刪除當前 P 花樣號碼。

⑥ 查看已登記 P 花樣

按以下兩個按鍵可以查看共登記了多少 P 花樣。

用戶最多可登記 255 個 P 花樣。

 : P 花樣上翻頁

 : P 花樣下翻頁

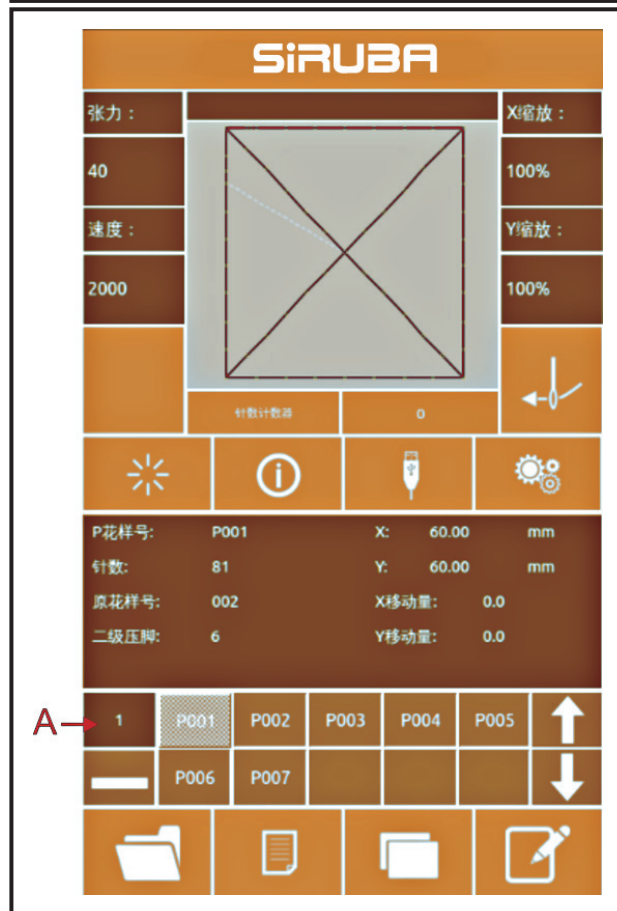
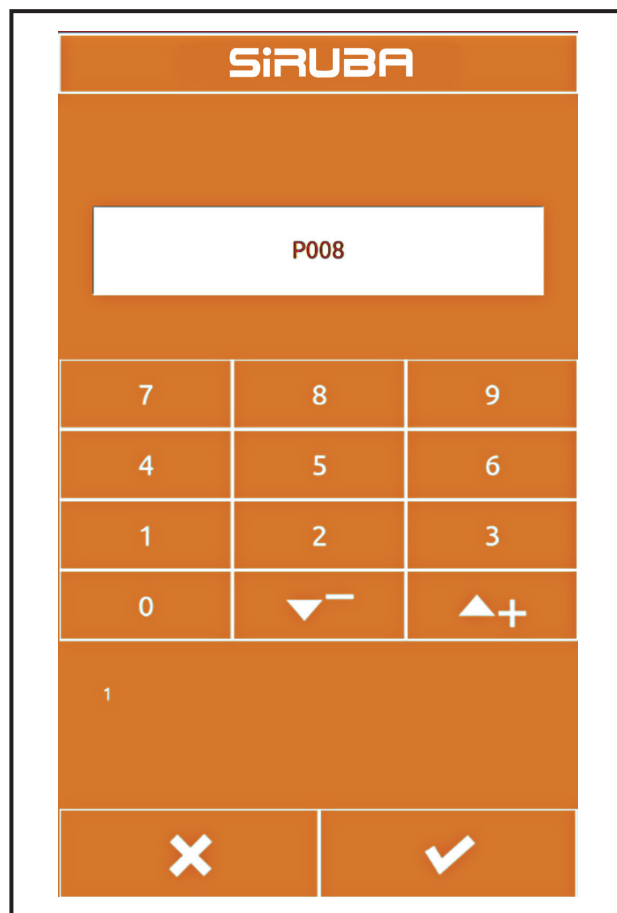

試縫操作

① 顯示縫製介面

在資料登錄介面，按準備鍵  之後，準備鍵變為  狀態，表示進入縫製介面。

② 顯示試縫介面

在縫製介面下，按下  鍵後進入試縫介面（如右圖所示）：

A	花樣圖案顯示區域
B	花樣資訊顯示區域
C	張力基準值設置按鍵
D	中壓腳基準值設置按鍵
	單針後退按鍵
	單針前進按鍵
	N 針移動按鍵
	剪線按鍵
	穿線按鍵
	圖形顯示放大按鍵
	圖形顯示縮小按鍵

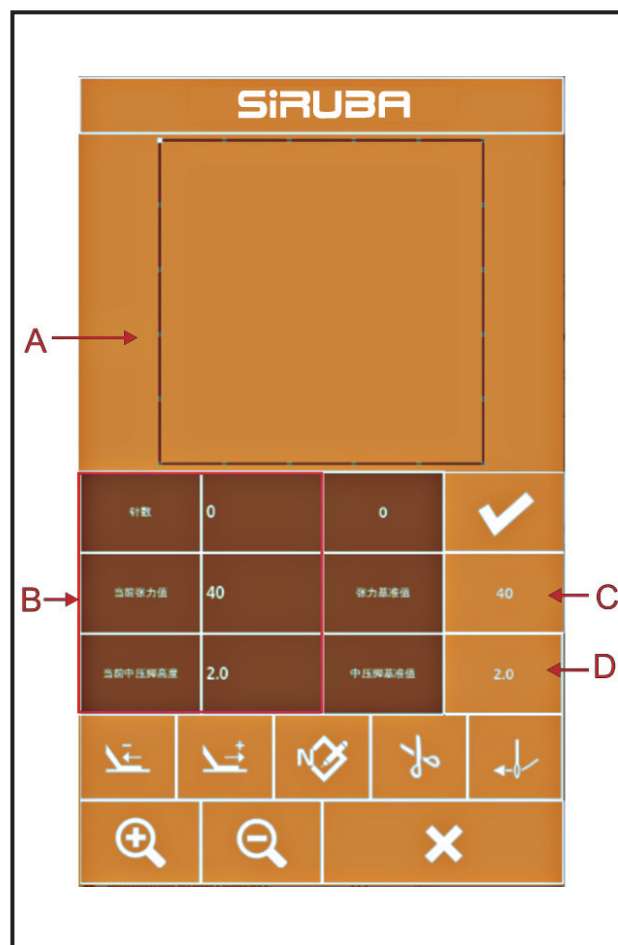

③ 開始試縫

進入試縫介面後壓腳下降，用壓腳後退鍵  和壓腳前進鍵  確定形狀。

或應用 N 針前進按鍵  直接移動到第 N 針。

④ 試縫介面啟動縫製

在試縫介面可以在任意位置直接踩踏啟動踏板，機器將從當前位置啟動縫製並返回縫製介面。

⑤ 結束試縫

按了取消鍵  退出試縫介面之後，返回縫製介面，並回到花樣起點位置。

計數器操作

① 顯示計數器介面

輸入介面或縫製介面中如圖 A、B 位置為計數器顯示位置

A	計數器模式按鍵	1：縫製計數器 2：針數計數器
B	計數值顯示按鍵	1：縫製件數 2：縫製針數

使用者可直接點擊 A 計數器模式按鍵快速切換“計件計數器 / 針數計數器”，在 B 按鍵位置處顯示相應“件數 / 針數”。

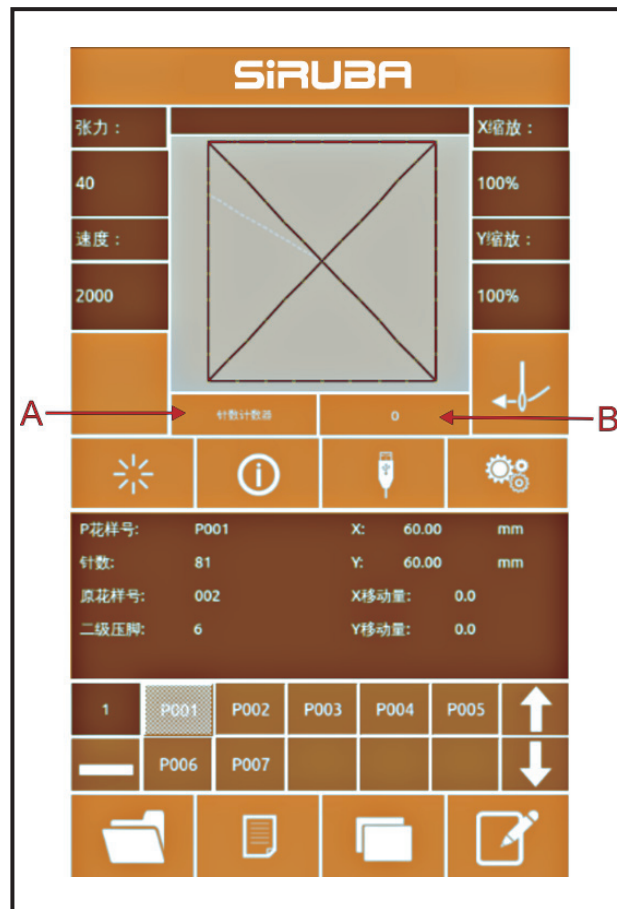

② 計數器清零操作

點擊按鍵 B，彈出重新計數介面，如圖所示，點擊 C 按鍵，計數器清零，並返回上一介面輸入介面 / 縫製介面。

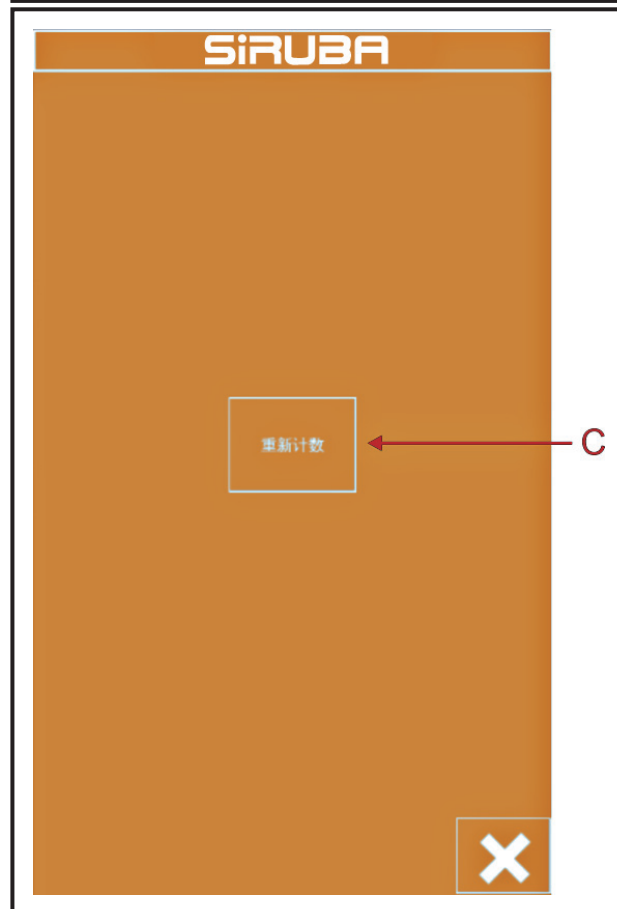

③ 設置計數器操作

在設置介面中點擊 D 按鍵，進入計數器設置介面

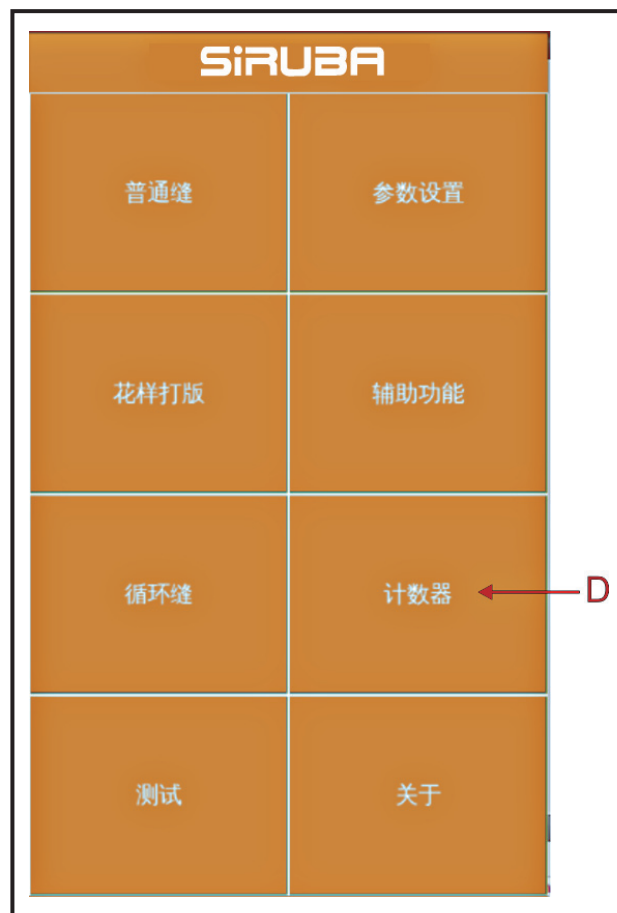

E	縫製計數器模式
F	計件當前計數值
G	縫製計數器最大值
H	針數計數器模式
I	針數計數器當前值
J	針數計數器最大值

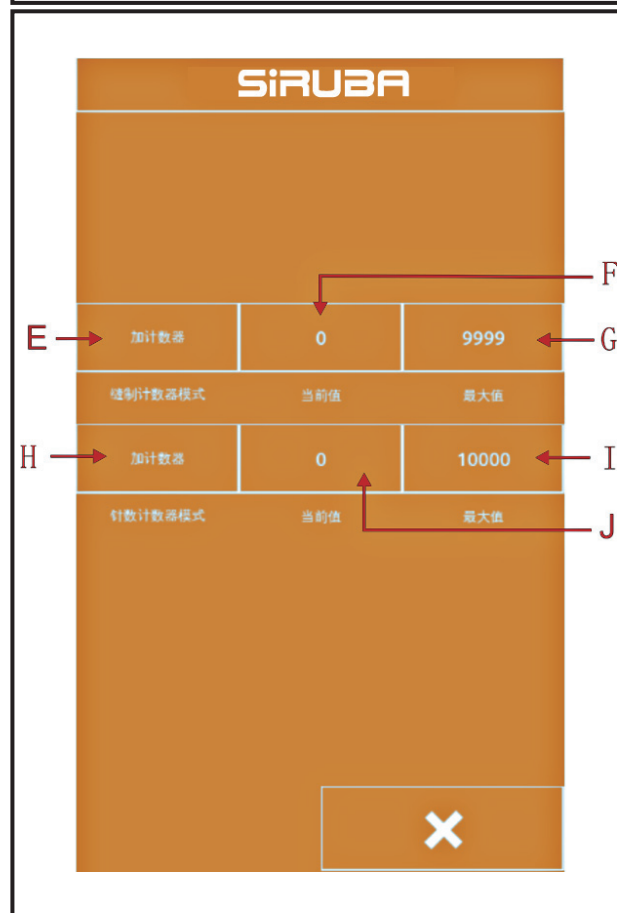

1. 設置計數器類型

點擊 E 或 H 鍵進入計數器模式設置介面，

可將模式設置成“加計數器 / 減計數器 / 不使用計數器”，模式設置完成後，按  鍵，返回上一介面。

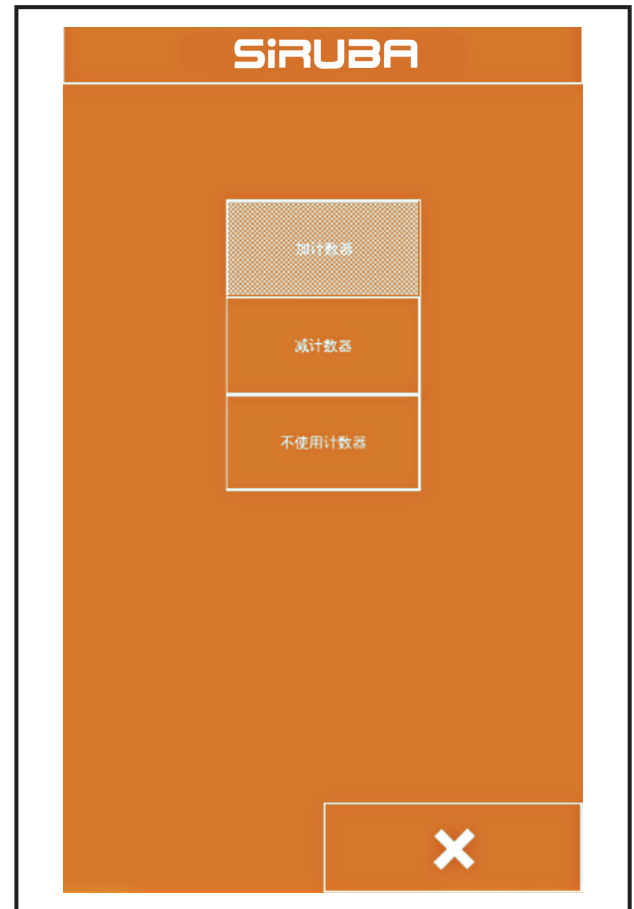

2. 設定計數值

點擊 F/J 或 G/I, 可分別設定當前計數值和最大計

數值，通過  ~  十數位鍵盤或 

、 鍵輸入數值。

注：縫製計數器最大值為 9999 件，針數計數器最

大值為 65000 針。

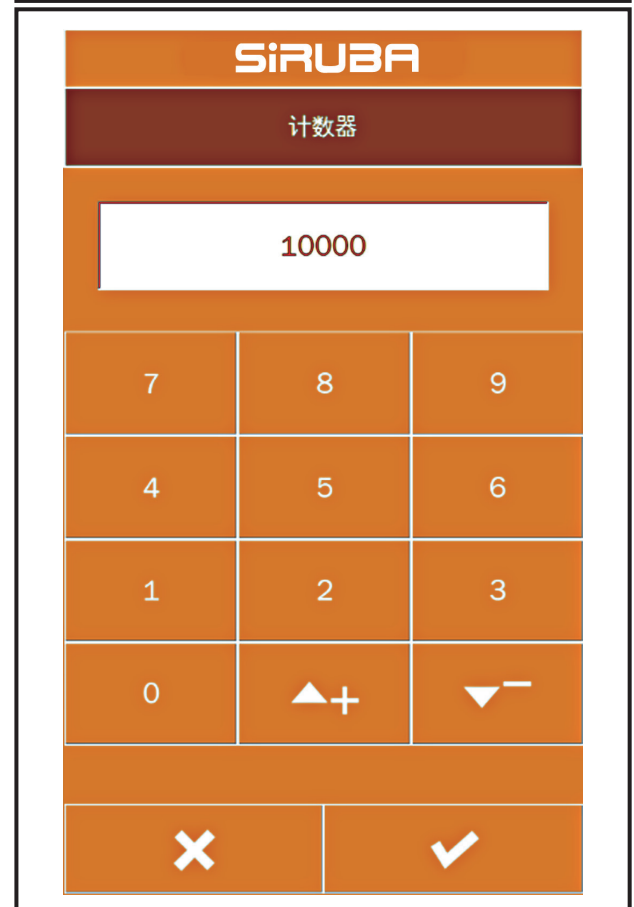

調整起縫點操作

① 進入調整起縫點介面

在資料登錄介面，按調整起縫點按鍵 之後，進入調整起縫點介面。如右圖。

A	模擬縫後退鍵
B	模擬縫前進鍵
C	當前所處針數
D	一次移動針數選擇鍵
E	調整量資料顯示
F	顯示繪圖區域
G	調整起縫點移動鍵盤
H	抬落中壓腳按鍵

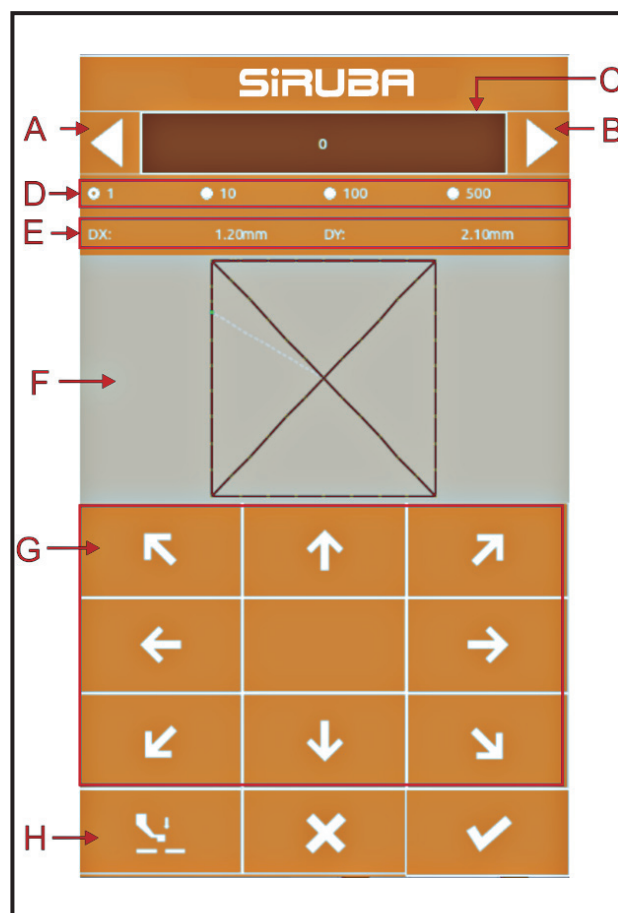

② 開始調整起縫點

按 G 區域的移動鍵盤移動起縫點，使機針對准範本的起縫點。對完起縫點以後，可以按 A、B 按鍵 “類比走按紐”，檢驗是否對準。

模擬走默認一次移動 1 針，可以通過點擊 D 區域選項按鈕，選擇一次移動 10 針、100 針或 500 針。

注：起縫點已經對準的標準是：機針與花樣的縫製軌跡沒有偏差，若存在偏差說明仍需繼續調整，確認調整完

畢後按  鍵確認即可保存偏移量。

③ 結束試縫

按了取消鍵  退出調整介面之後，返回輸入介面。

急停

急停開關被按下後，按確認鍵後進入是縫製介面，可通過試縫製介面進行針數前進、後退或剪線等操作，操作步驟參照【2.11 試縫製操作】

快捷 (P) 花樣操作

P 花樣資料登錄

快捷花樣簡稱 P 花樣，由一個普通花樣和相關花樣縫製參數 (X 縮放率、Y 縮放率、速度限制等) 組成。

選用 P 花樣不需要每次設置相關參數。

P 花樣資料登錄介面如右圖所示。

最多可以登記 255 個 P 花樣。

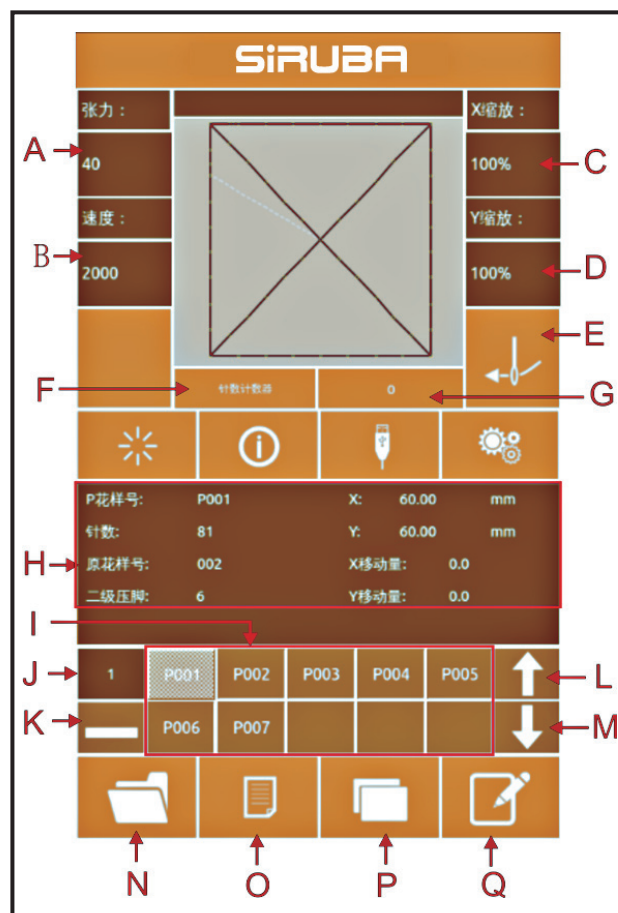

功能說明：

序號	功能	內容
A	張力值	顯示當前花樣張力
B	速度值	顯示當前花樣速度值
C	X 縮放率	最多可以輸入 14 個字元。
D	Y 縮放率	按下之後外壓腳下降。
E	穿線	按下後顯示紅色  為穿線狀態，不可進行其他操作
F	計數器模式	分為縫製計數器和針數計數器，點擊按鍵可快速切換計數器模式及計數顯示
G	計數器值	根據計數器模式的不同，顯示相應的當前計數值
H	P 花樣資訊顯示	顯示為當前 P 花樣縫製資訊。
I	已登記的 P 花樣	按鍵可快捷切換 P 花樣。
J	P 花樣頁數	顯示當前 P 花樣所處頁數，按鍵可順序切換 P 花樣頁碼。
K	P 花樣刪除鍵	點擊該按鍵可刪除選中的 P 花樣。
L	P 花樣上翻頁	點擊按鍵 P 花樣上翻頁
M	P 花樣下翻頁	點擊按鍵 P 花樣下翻頁
N	普通花樣選擇鍵	點擊按鍵可選擇已登記的普通花樣
O	普通花樣登記按鍵	登記新的普通花樣
P	P 花樣複製按鍵	可以複製當前 P 花樣內容到一個空花樣號碼下
Q	花樣命名鍵	可以為當前花樣命名

P 花樣編輯

① 進入 P 花樣編輯介面

按  鍵選擇普通花樣，對普通花樣的參數進行編輯，修改縮放率，中壓腳，張力，速度等參數值，修改完畢後登記 P 花樣參照【2.10 P 花樣登記】，即得到新的 P 花樣。

② 編輯專案資料變更

選擇想要變更的項目，設置數值。

	項目	輸入範圍	初始值
A	縫製張力	0~120	40
B	縫製速度	400~3000rpm	2000rpm
C	X 方向縮放	1%~400%	100.0%
D	Y 方向縮放	1%~400%	100.0%
E	中壓腳高度	0.0~7.0mm	2.0mm
F	壓腳高度	10~25mm	17mm
G	花樣命名	字串	無
H	XY 偏移量	---	0

③ 確定資料變更

以設置 XY 方向偏移量為例，通過方向鍵盤對 XY

起點進行移動，按下確定鍵  完成操作。參照

【2.13 調整起縫點操作】

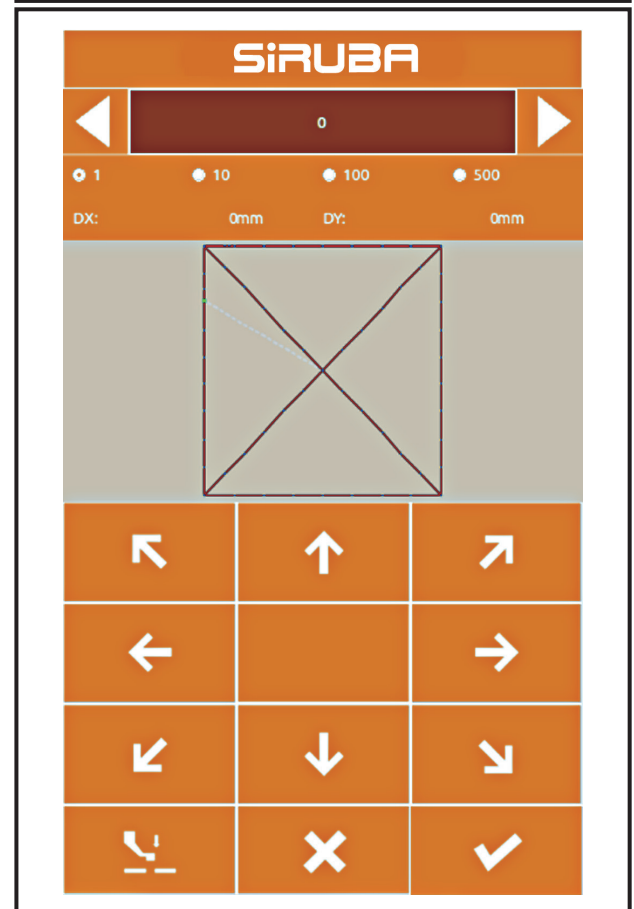
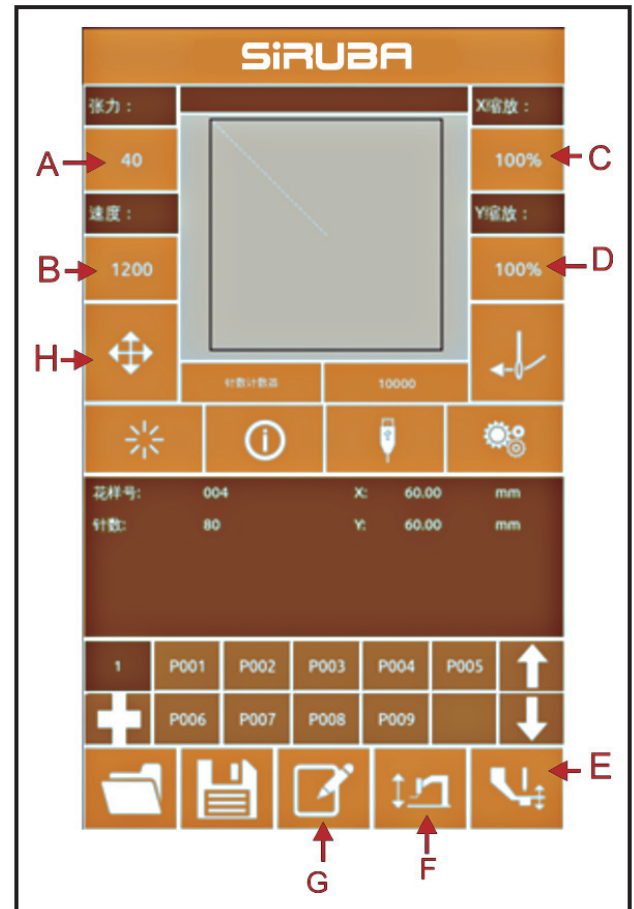

P 花樣縫製

在 P 花樣資料登錄介面下，按下  進入縫製介面。

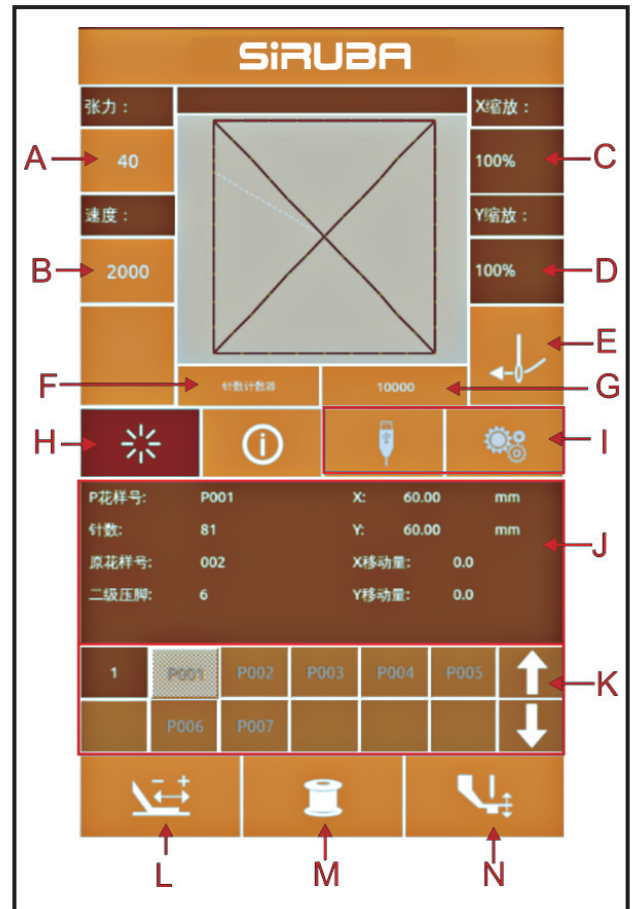

功能說明：

序號	功能	內容
A	張力按鍵	按下後進入張力設置介面，可以設定縫製張力值。
B	速度按鍵	設定當前縫製速度。
C	X 方向縮放顯示	顯示當前花樣的 X 縮放率。
D	Y 方向縮放顯示	顯示當前花樣的 Y 縮放率。
E	穿線按鍵	按下後按鍵呈紅色  ，進入穿線狀態，此時不可進行其他操作。
F	計數器模式按鍵	按下後可快速切換“縫製計數器 / 針數計數器”。
G	計數顯示按鍵	根據 F 按鍵的模式不同，顯示相應的計數，按下後可進入清零介面，可將當前計數清零。
H	花樣確認鍵	切換“花樣輸入狀態 / 縫製狀態”。
I	不可操作按鍵	當前狀態不可操作。
J	花樣資訊顯示	顯示當前花樣的參數值。
K	不可操作按鍵	當前狀態不可操作。
L	試縫製按鍵	按下按鍵後可進入試縫製介面，確認花樣針跡。
M	繞線按鍵	按下後進入繞線介面。
N	中壓腳高度按鍵	按下後進入中壓腳高度設定介面，可設定縫製的中壓腳高度。

組合（C）花樣操作

C 花樣資料登錄

組合花樣簡稱 C 花樣，由一組 P 花樣組成，每組 C 花樣可以輸入最多 6 個子花樣。一共可以登記最多 50 組 C 花樣。

如右圖所示。

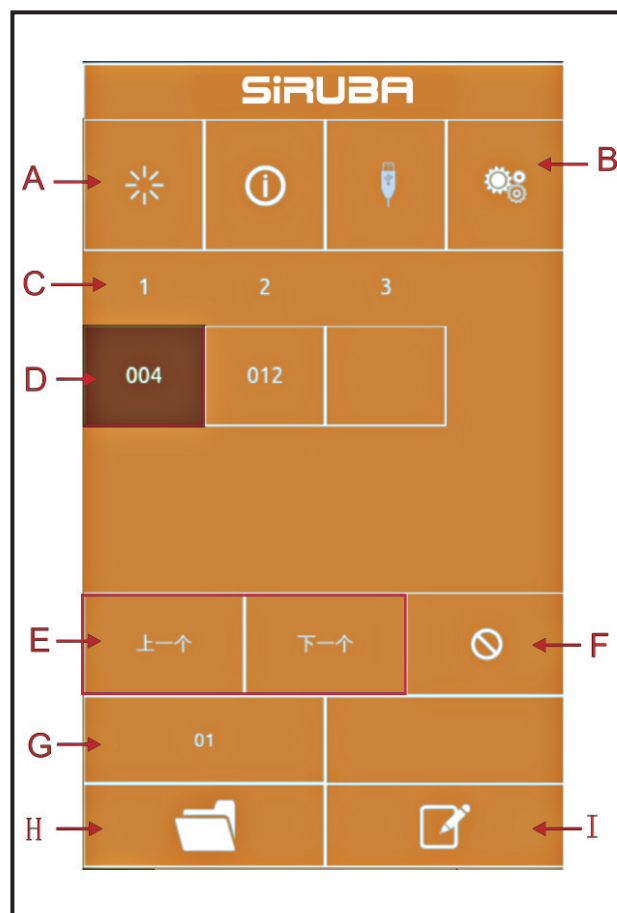

功能說明：

序號	功能	內容
A	確認鍵	進入縫製狀態
B	C 花樣複製	可以複製當前 C 花樣內容到一個空花樣號碼下。
C	縫製順序顯示	顯示當前選擇花樣的縫製順序，藍色顯示為起始縫製圖案。
D	C 花樣圖案選擇	按下後進入 C 花樣編輯介面，可以選擇輸入一個 P 花樣。
E	翻頁鍵	C 花樣圖案最多可以登記 30 個，每頁最多顯示 6 個圖案。
F	刪除鍵	刪除 C 花樣序列
G	C 花樣號碼選擇	按鍵上顯示當前選擇花樣號碼，按下後進入 C 花樣選擇介面。
H	C 花樣登記	登記一個新組合花樣。
I	花樣命名	輸入想要命名的字串
J	C 花樣名稱	顯示 C 花樣名稱。

C 花樣編輯

① 進入 C 花樣編輯介面

在 C 花樣資料登錄介面下，按下 A 可以進入 C 花樣編輯介面。

在初期狀態下，沒有登記到 P 花樣做為縫製圖案，因此第一個圖案以空白狀態顯示。

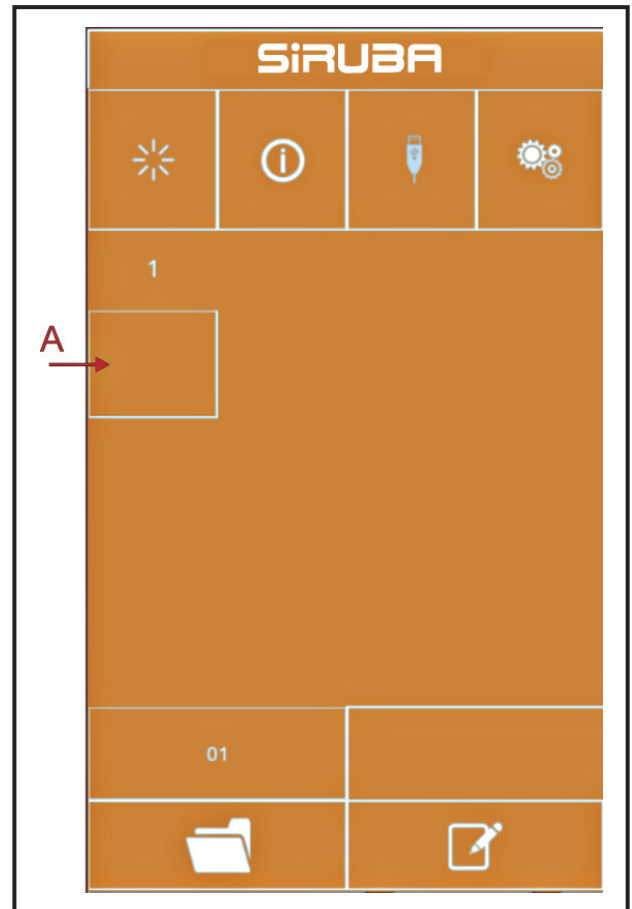

② 選擇圖案

右圖為 C 花樣編輯介面，選擇想要登記的 B 區域

的 P 花樣圖案，按下確定鍵  之後結束選擇。

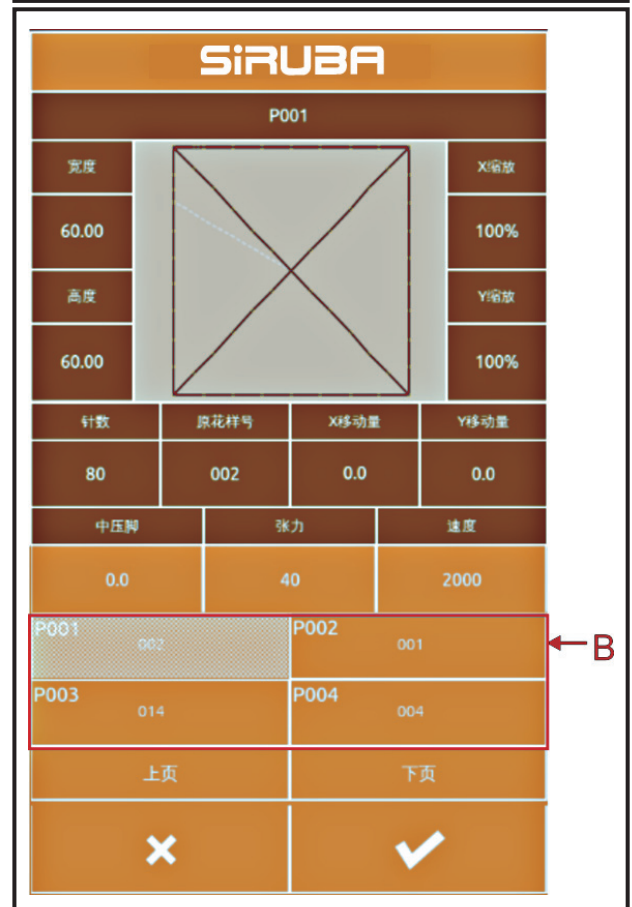

③ 反復登記剩餘圖案

一個圖案登記確定之後，下一個圖案選擇鍵 C 被顯示出來如上圖，操作同上，可以反復登記其它剩餘圖案。

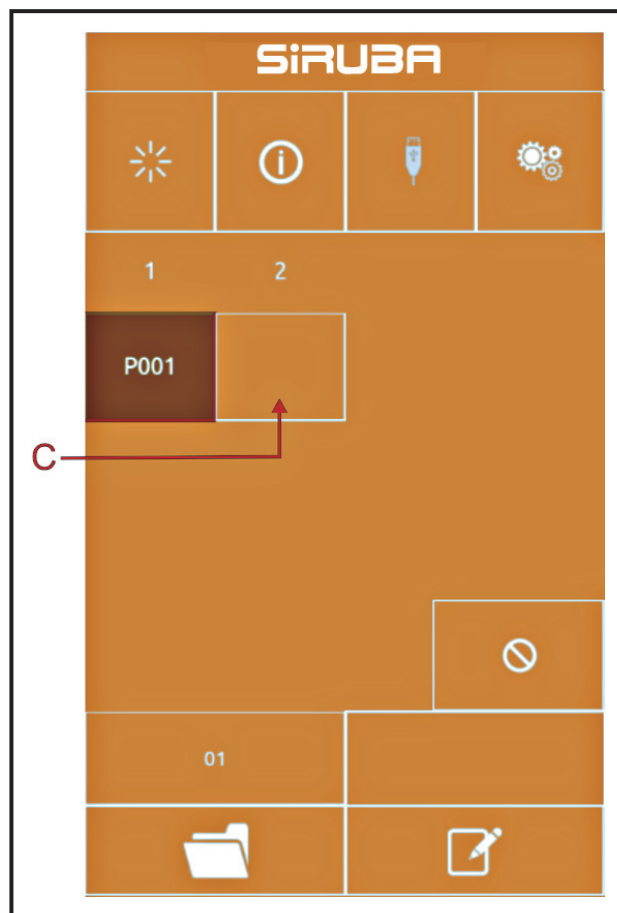

C 花樣選擇

① 進入 C 花樣選擇介面

如右圖所示，按下圖示 A，可以進入 C 花樣選擇介面。

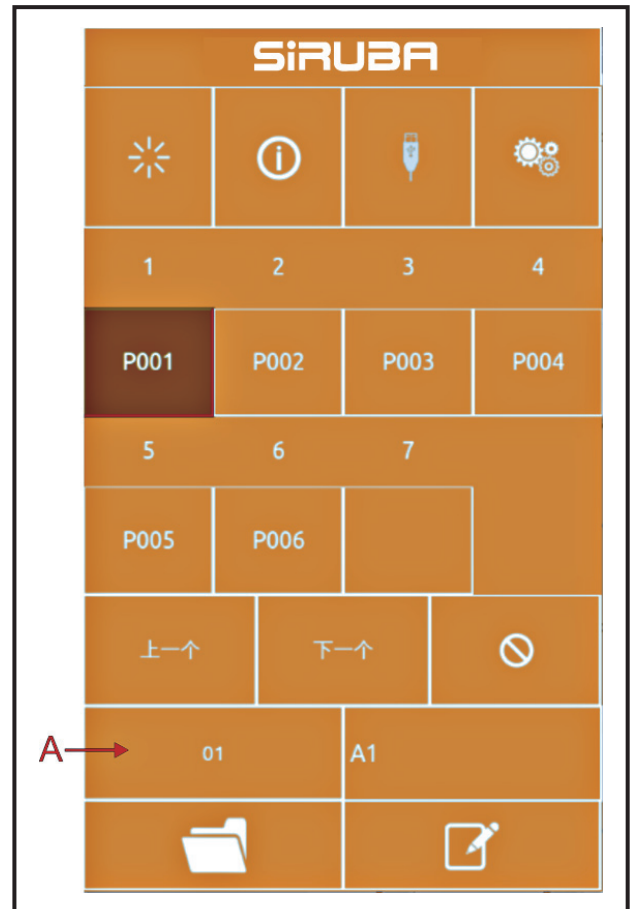

② 選擇 C 花樣號碼

右圖為 C 花樣選擇介面，按下 B 鍵之後，可以順序變換當前 C 花樣下輸入的 P 子花樣資料資訊。

確定要選擇的 C 花樣號碼鍵 C，按下確定鍵



之後結束選擇。

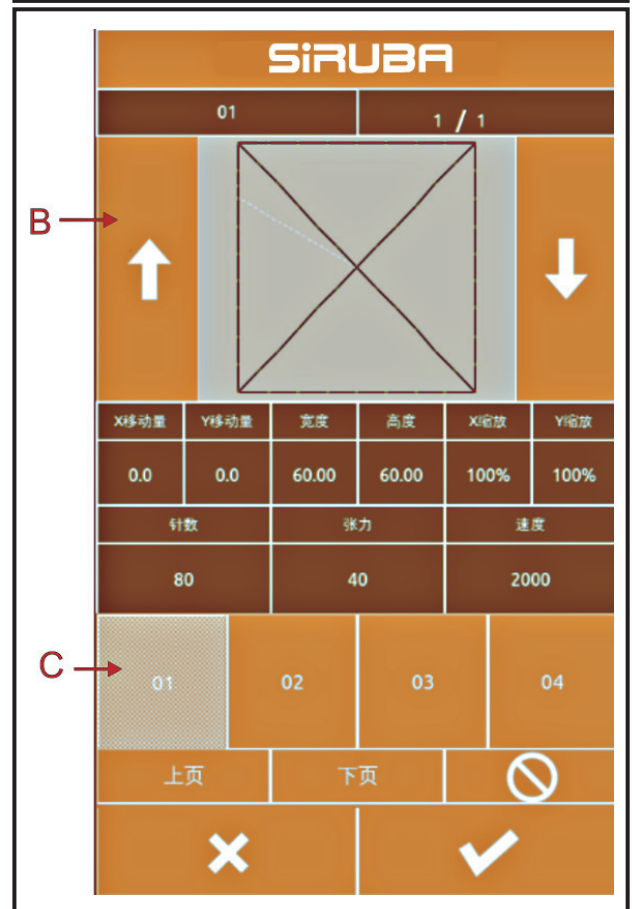

C 花樣縫製

在 C 花樣資料登錄介面下，按下  進入縫製介面（如右圖所示）。

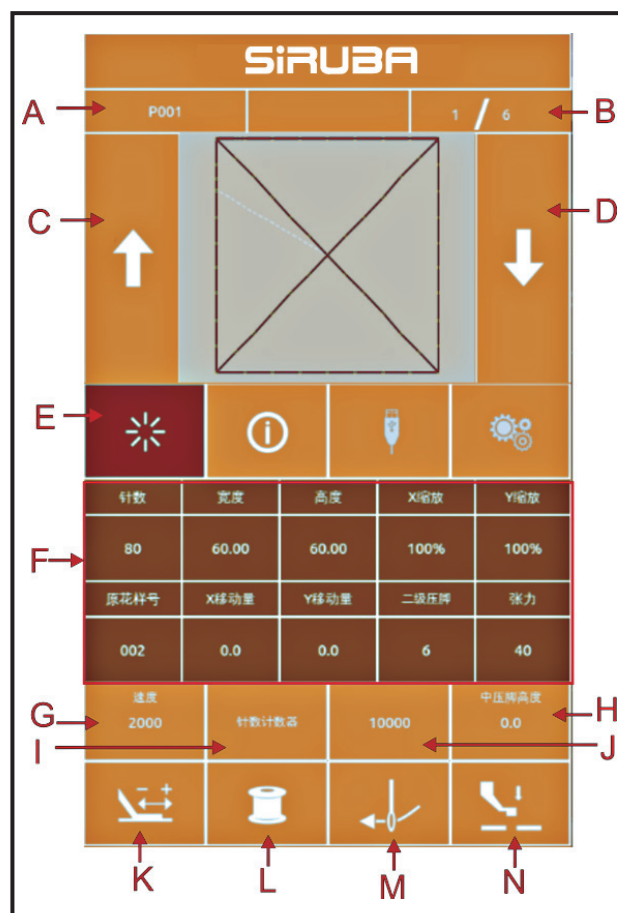

功能說明：

序號	功能	內容
A	縫紉形狀號碼顯示	顯示當前 C 花樣下登記的子花樣號碼。
B	縫製順序顯示	顯示當前縫製花樣中的縫製順序號
C	縫製花樣切換鍵	按下後縫製花樣切換到當前序列的上一個花樣。
D	縫製花樣切換鍵	按下後縫製花樣切換到當前序列的下一個花樣。
E	花樣確認鍵	切換 C 花樣輸入介面狀態和縫製介面狀態。
F	花樣資訊顯示	顯示當前縫製序列中當前子花樣的參數資訊。
G	縫製速度鍵	設定當前縫製序列中當前子花樣的縫製速度。
H	中壓腳高度按鍵	設定當前縫製序列中當前子花樣的中壓腳高度。
I	計數器模式按鍵	設定當前計數模式，“縫製計數 / 針數計數”。
J	花樣計數顯示	根據 I 的設定不同，顯示相應計數“件數 / 針數”。
K	試縫製按鍵	按下後進入試縫製介面，確認當前縫製序列中當前子花樣的針跡走勢。
L	繞線按鍵	按下後進入繞線介面。
M	穿線按鍵	按下後按鍵呈紅色  ，進入穿線狀態，此時不可進行其他操作。
N	中壓腳抬落按鍵	可控制中壓腳的抬落。

花樣圖案編輯

進入花樣編輯模式

按下普通縫製可以切換資料登錄介面和模式選擇介面（如右圖所示），在該介面下可以進行一些詳細的設置和編輯操作。

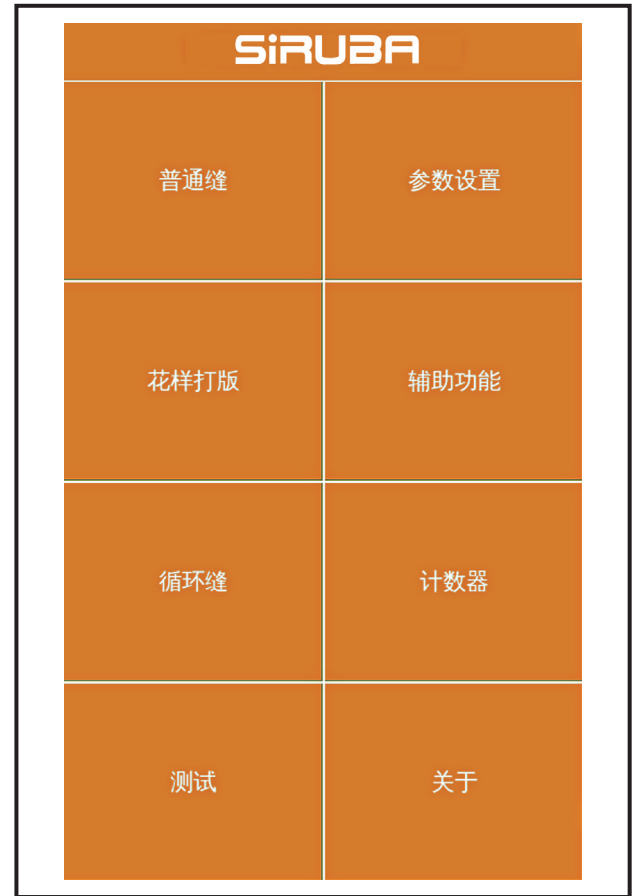

按下花样打版键进入花样编辑介面。

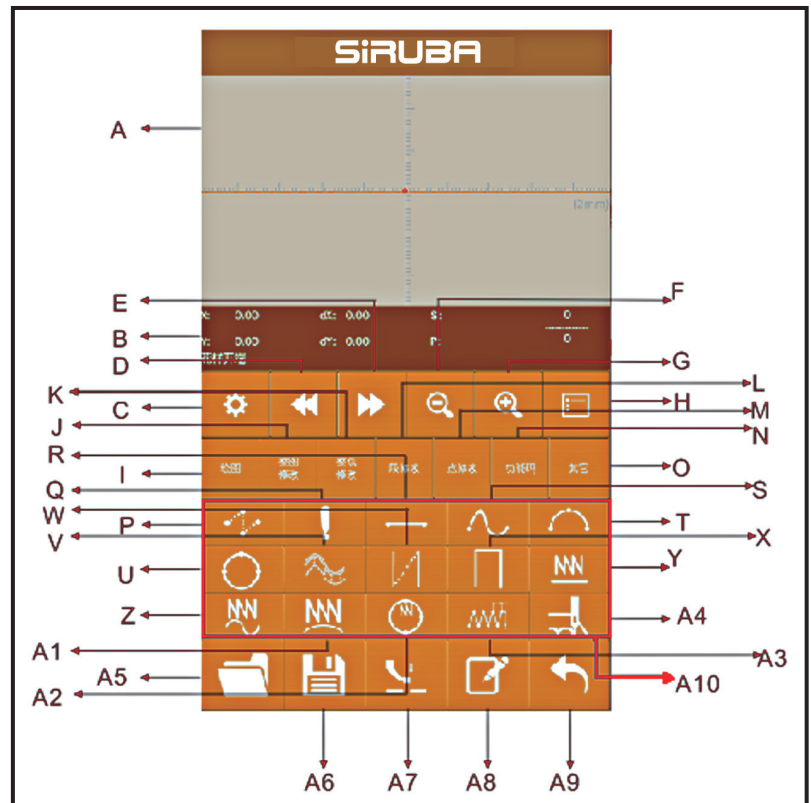

功能說明：

序號	功能	內容
A	花樣顯示區	顯示花樣圖案
B	當前針位置狀態資訊顯示區	顯示當前針的位置資訊
C	屬性設置	可以設置回針等屬性
D	後退送布	將當前針位置向後移動
E	前進送布	將當前針位置向前移動
F	縮小顯示	將花樣圖案縮小顯示
G	放大顯示	將花樣圖案放大顯示
H	功能列表	以清單的形式顯示出打版中的功能
I	繪圖	A10 區域顯示出繪圖相關按鈕
J	整圖修改	A10 區域顯示出整圖修改相關按鈕
K	整線修改	A10 區域顯示出整線修改相關按鈕
L	段修改	A10 區域顯示出段修改相關按鈕
M	點修改	A10 區域顯示出點修改相關按鈕
N	功能碼	A10 區域顯示出功能碼相關按鈕
O	其它	A10 區域顯示出其它相關按鈕
P	空送	繪製空送
Q	點縫	繪製點縫
R	直線縫	繪製直線
S	曲線縫	繪製曲線
T	圓弧縫	繪製圓弧
U	圓縫	繪製圓
V	多重縫	繪製多重縫
W	同向雙重縫	繪製同向雙重縫
X	逆向雙重縫	繪製逆向雙重縫
Y	直線曲折縫	繪製直線曲折縫
Z	曲線曲折縫	繪製曲線曲折縫
A1	圓弧曲折縫	繪製圓弧曲折縫
A2	圓曲折縫	繪製圓曲折縫
A3	直線曲折縫 2	繪製直線曲折縫 2(每段可設置多個點)
A4	跳縫	繪製跳縫
A5	打開	打開花樣文件
A6	保存	將當前顯示圖案保存為花樣檔
A7	中壓腳升降	抬升或下降中壓腳
A8	命名	為花樣命名
A9	退出	退出打版
A10	動態按鈕顯示區	根據按鈕 (I、G、K、L、M、N、O) 不同的選擇，顯示對應相關按鈕。

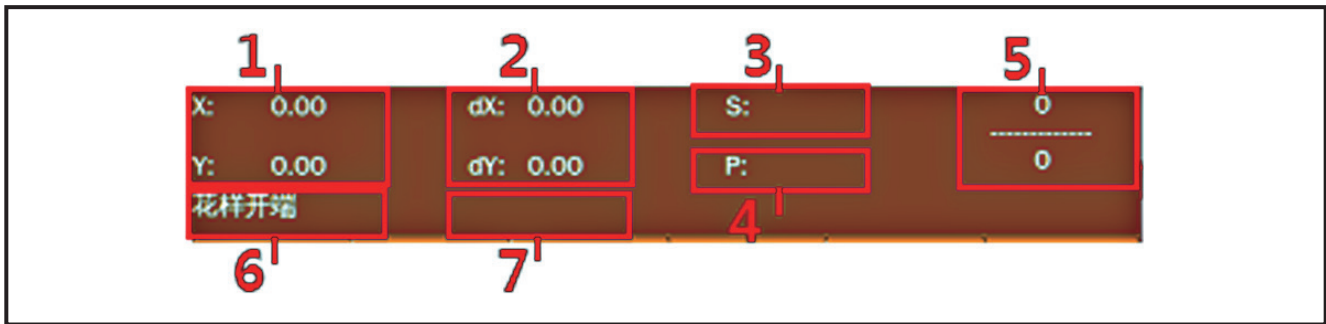

功能說明：

序號	功能	內容
1	絕對座標	表示從現在的機針位置的原點的絕對座標。
2	相對座標	表示現在的機針位置的相對座標。
3	速度	表示當前點的縫製速度或空送速度。
4	間隔	表示現在的要素縫製針跡長度。
5	針數	分子表示當前針數，分母表示總針數。
6	落針種類	表示有關落針位置的種類。
		花样開端，表示是圖案的起點位置。
		線段中間點，表示是一條線的中途點（即不是頂點也不是線段終端）。
		頂點，表示是折線的頂點。
		線段終端，表示是一條線的終端位置。
6	花样終端，表示是圖案的最終位置。	
7	線或功能碼種類	縫製資料時，顯示該線種類（空送、折線縫、曲線縫等）。功能碼時，顯示該功能碼的種類（切線等）。

花樣編輯

輸入點：

使用花樣編輯功能，輸入如下花樣圖案。

	X (mm)	Y (mm)
1	-40.00	25.00
2	40.00	25.00
3	40.00	-25.00
4	-40.00	-25.00

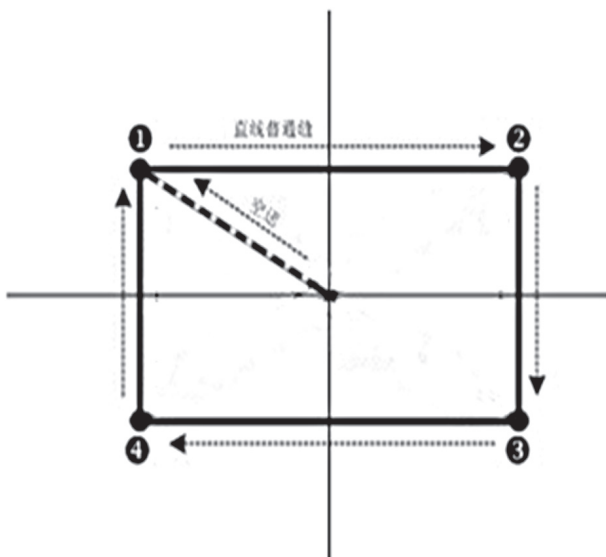

輸入次序：如左圖中虛線箭頭所示。

①空送的輸入

在花樣編輯標準介面，按空送按鈕 ，顯示出空送設定介面（如右圖所示）。

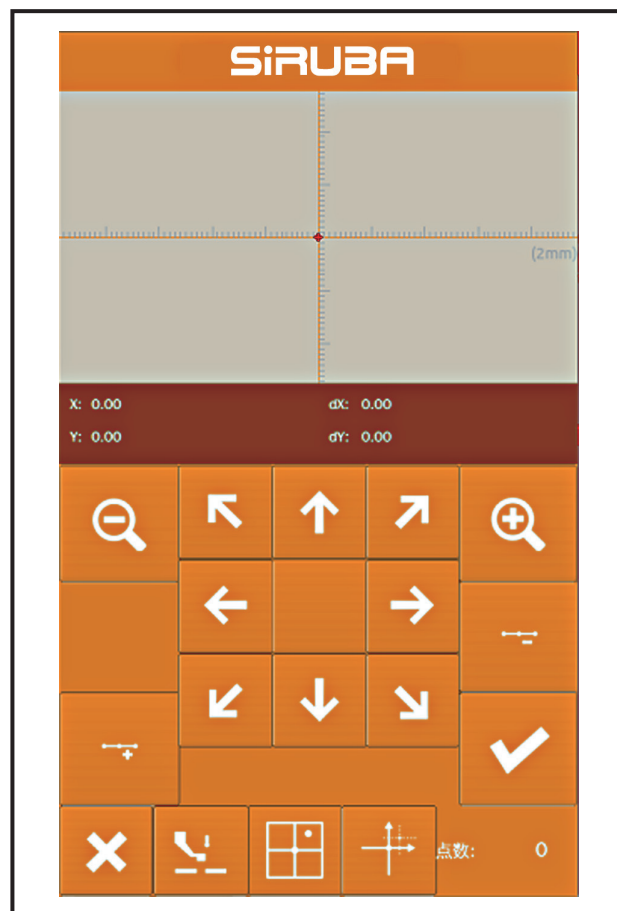

在空送位置指定介面，使用移動鍵，移動游標（機針位置）到（-40，25）處，按  按鈕確定後，退回到花樣編輯標準介面並顯示出空送針跡（如右圖所示）。



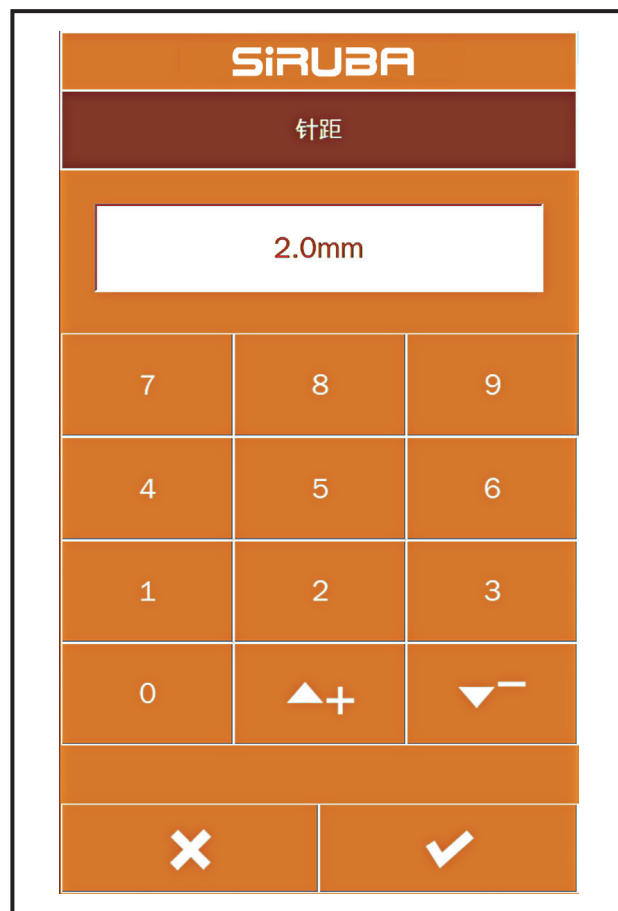

②直線普通縫的輸入

在花樣編輯標準介面按直線縫鍵  後，進入直線普通縫針距設置介面，如右圖所示。依次按 3、0 數位鍵，將縫跡長度變更為“3.0”，按確認鍵保存並退回到直線普通縫設置介面。



確認針距的顯示值為“3.0mm”之後，按確認鍵

，進入直線普通縫位置設定介面。

在此介面下，按移動鍵，將游標（機針位置）從 1 處移動到 2 處，然後按插入點按鈕 。反復進行上述移動操作，將游標按照 1 2 3 4 的順序依次移動，如右圖所示。

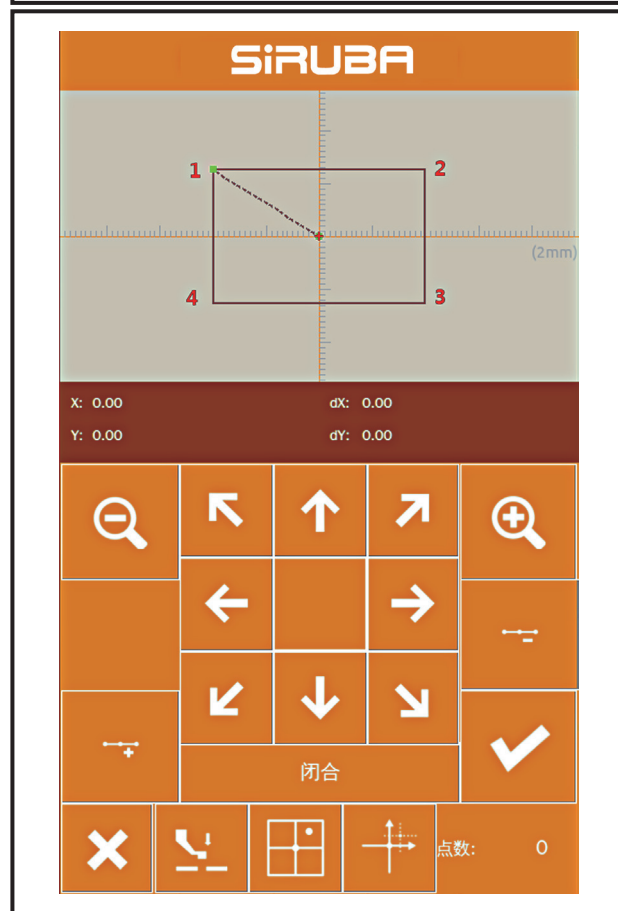

確認花樣圖案後，按 鍵生成花樣資料並返回到花樣

編輯標準介面，顯示出花樣圖案。



③保存花樣

按  按鈕，進入圖案花樣保存介面，保存編輯好的花樣圖案，如右圖所示。

系統自動設定好樣號碼，使用者也可以通過數位

鍵盤輸入希望值。按  鍵後保存花樣圖案。

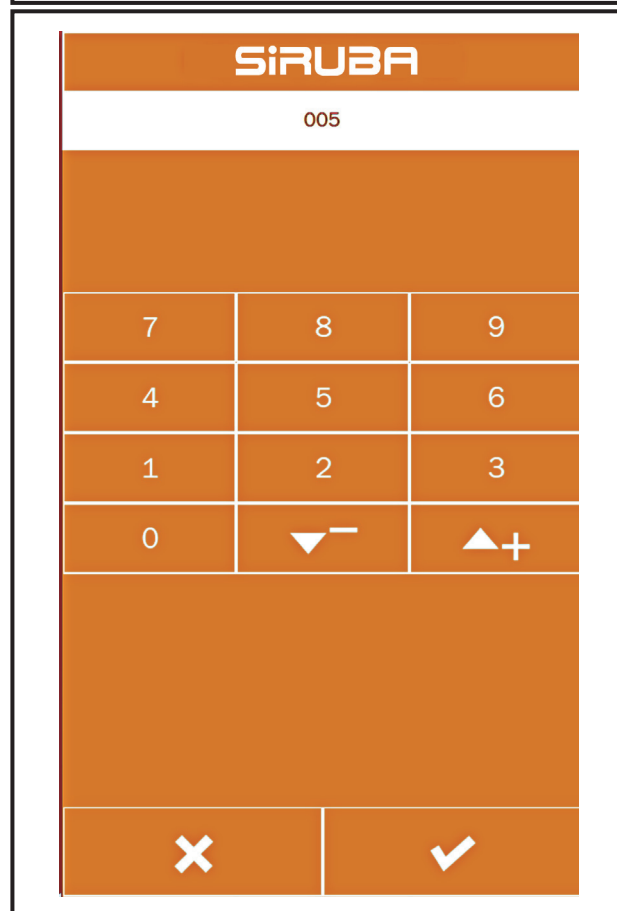

花樣的修改

1: 整圖修改：按整圖修改按鈕動態按鈕顯示區顯示如

下功能按鈕：

- (A): 移動起縫點按鈕
- (B): 修改整個圖形針距
- (C): 移動第二原點

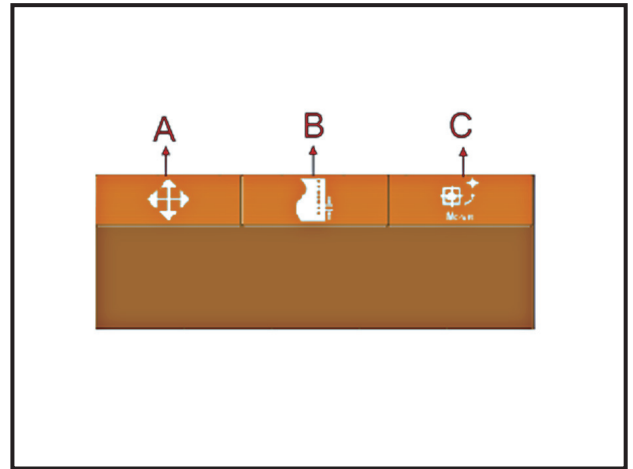

2: 整線修改按鈕：按整線修改按鈕動態按鈕顯示區顯示如下功能按鈕：

示如下功能按鈕：

- (A): 修改當前線的針距
- (B): 移動當前線
- (C): 移動多條線
- (D): 複製當前線
- (E): 刪除當前線
- (F): 移動當前線和後面所有線

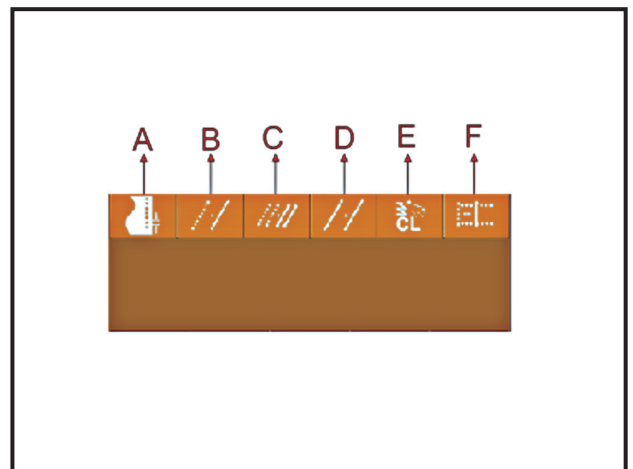

3: 段修改按鈕：按段修改按鈕動態按鈕顯示區顯示如下功能按鈕：

下功能按鈕：

- (A): 區段移動
- (B): 區段修改
- (C): 區段刪除

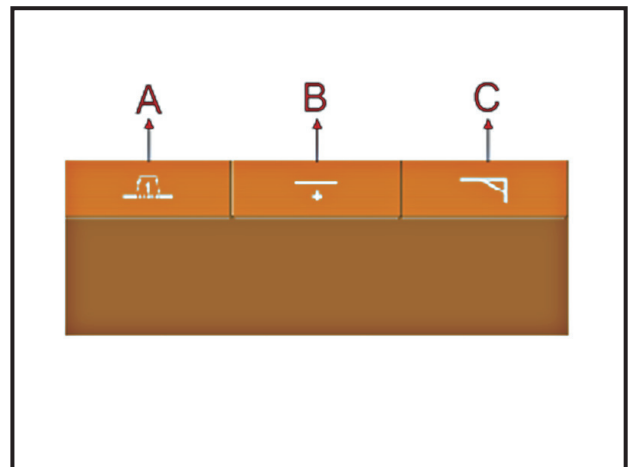

4: 點修改按鈕：按點修改按鈕動態按鈕顯示區顯示如

下功能按鈕：

- (A): 移動點
- (B): 添加點
- (C): 刪除點

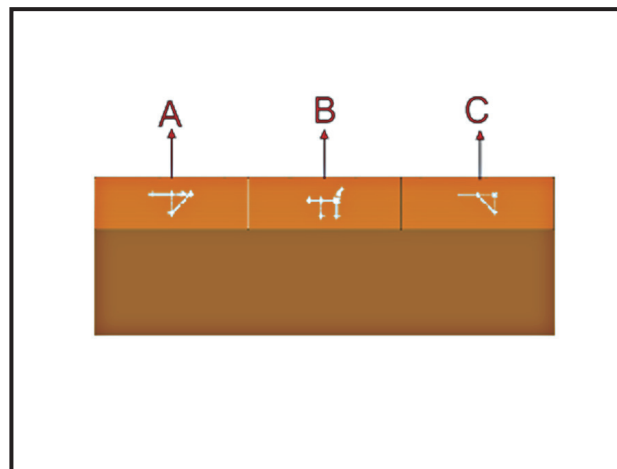

5: 功能碼按鈕：按功能碼按鈕動態按鈕顯示區顯示如下功能按鈕：

- (A): 剪線
- (B): 第二原點
- (C): 中途停止
- (D): 線張力基準值
- (E): 中壓腳高度基準值
- (F): 線張力
- (G): 中壓腳高度
- (H): 刪除功能碼
- (I): 縫製速度
- (J): 空送速度
- (K): 縫紉機停止
- (L): 外部輸入
- (M): 外部輸出
- (N): 編輯功能碼
- (O): 側滑，翻轉和其他專用擴展設備。

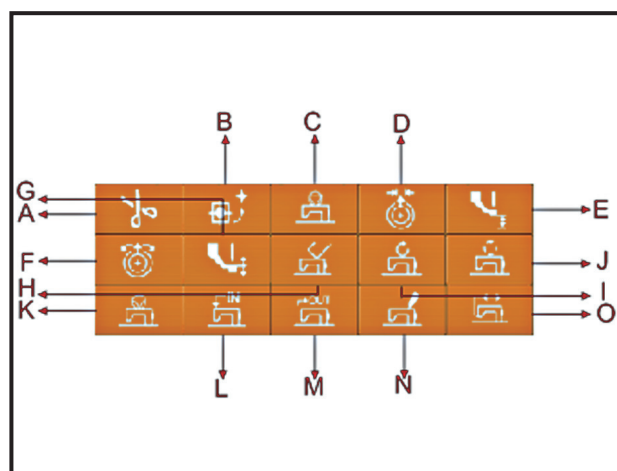

6: 其它：按其它按鈕動態按鈕顯示區顯示如下功能按鈕：

- (A): 移動到指定針
- (B): 更換範本功能
- (C): 移動空送

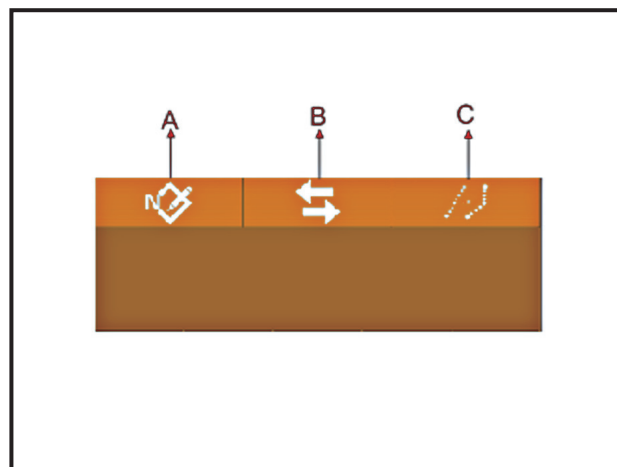

退出花樣編輯模式

在花樣編輯標準介面下，按 進入模式選擇介面，如

右圖所示。



資訊功能

查看版本資訊

1 顯示資訊介面

在資料登錄介面，按如右圖所示的資訊按鍵（A）之後，資訊介面被顯示出來。

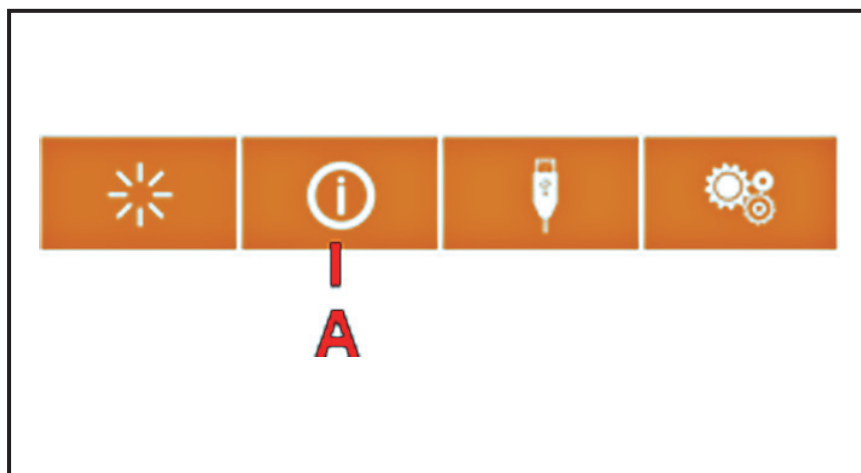

2 顯示版本介面。

請按資訊介面的版本按鍵，版本介面被顯示出來。在版本介面上，可以查看版本資訊。

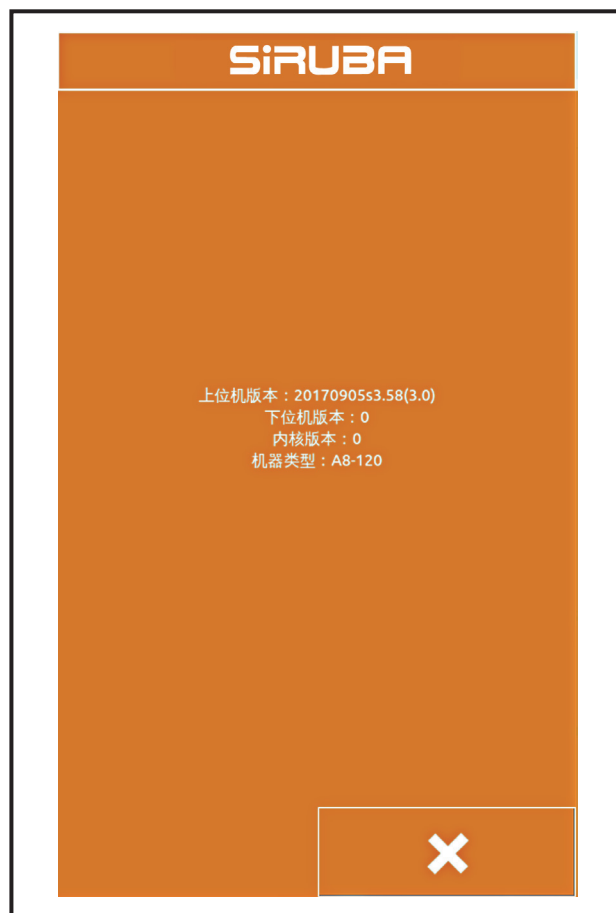
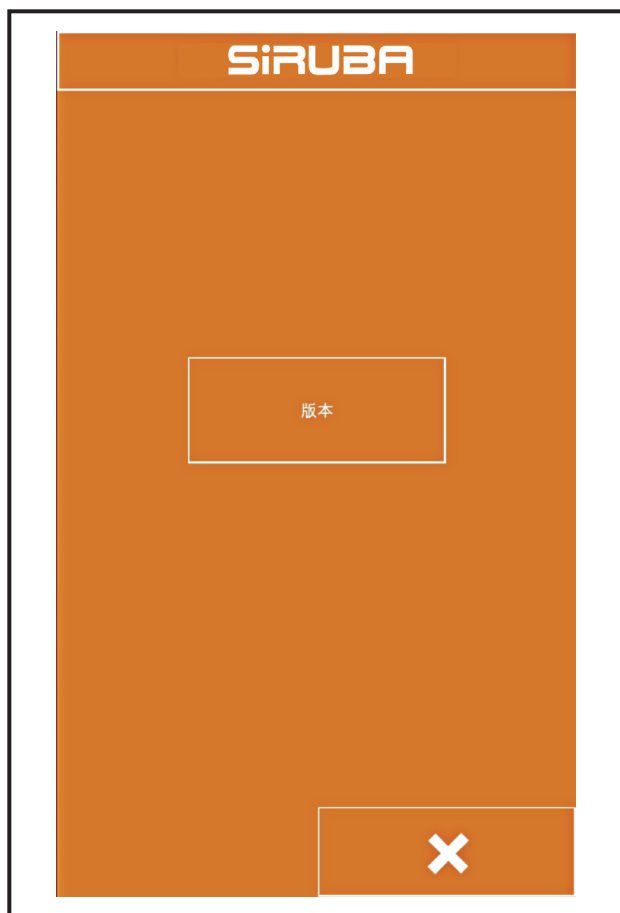

通訊功能

通信功能完成以下幾項功能：

將其它縫紉機編制的或打版軟體編制的縫製資料通過 U 盤拷貝到操作面板；將操作面板裡面的縫製資料拷貝到 U 盤。

關於可以處理的資料

可以處理的縫製資料如下：

資料類型	標準格式
VDT	VD00[0-9][0-9][1-9].VDT
sew	ISMS0[0-9][0-9][1-9].sew

花樣傳輸

1. 從 U 盤拷貝花樣檔到操作盤

在資料登錄介面，按通信鍵  之後，顯示出通信介面，如右圖所示。

- (1) 選中  按鈕，這個按鈕表示從 U 盤拷貝花樣檔到操作盤；

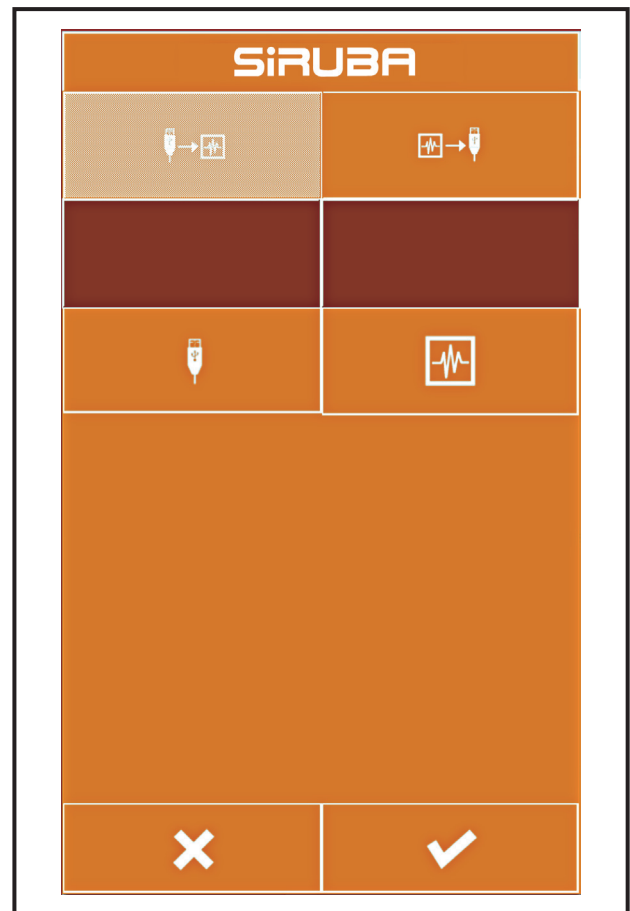

(2) 按 U 盤按鈕  顯示出選擇 U 盤檔介面，如右圖所示。找到需要複製的檔按確定按鈕

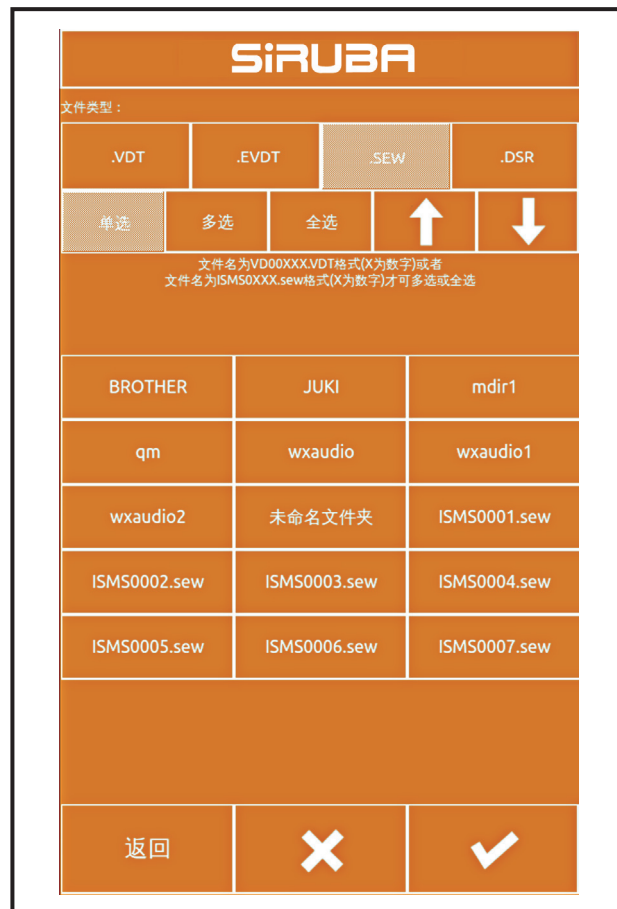

(3) 按操作盤按鈕 ，顯示出輸入檔號介面，如右圖所示，這個檔號是檔拷貝到操作盤以後

的檔號，輸入檔號以後按確定按鈕 。



(4) 從 U 盤選擇好檔並且輸入完操作盤檔號以後，

如右圖所示，按確定按鈕 ，這樣就可以

將 U 盤中的檔拷貝到操作盤。

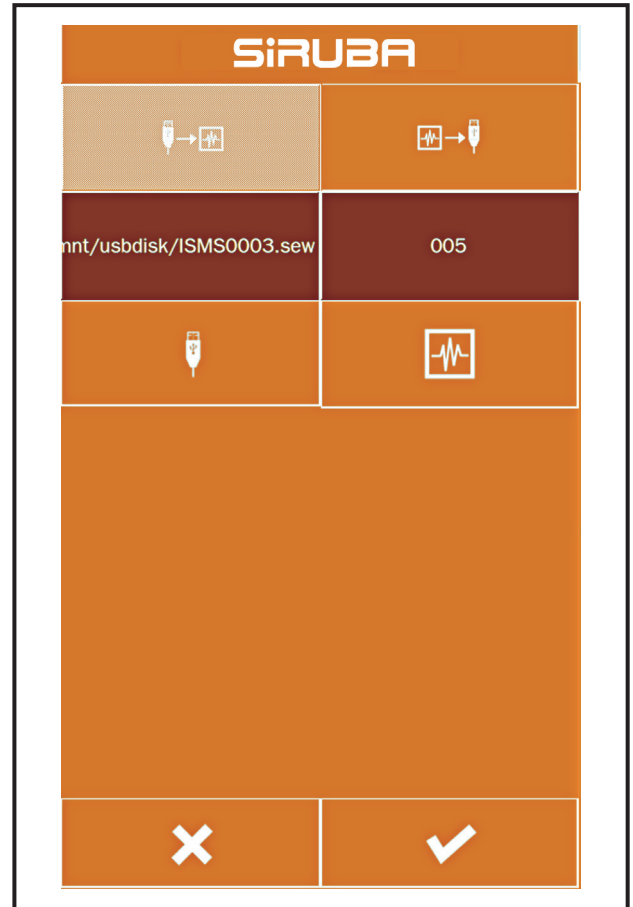

2. 從操作盤拷貝檔保存到 U 盤

在資料登錄介面，按通信鍵  之後，顯示出通信介面，如右圖所示。

(1) 選中  按鈕，這個按鈕表示從操作盤拷貝花樣檔到 U 盤；

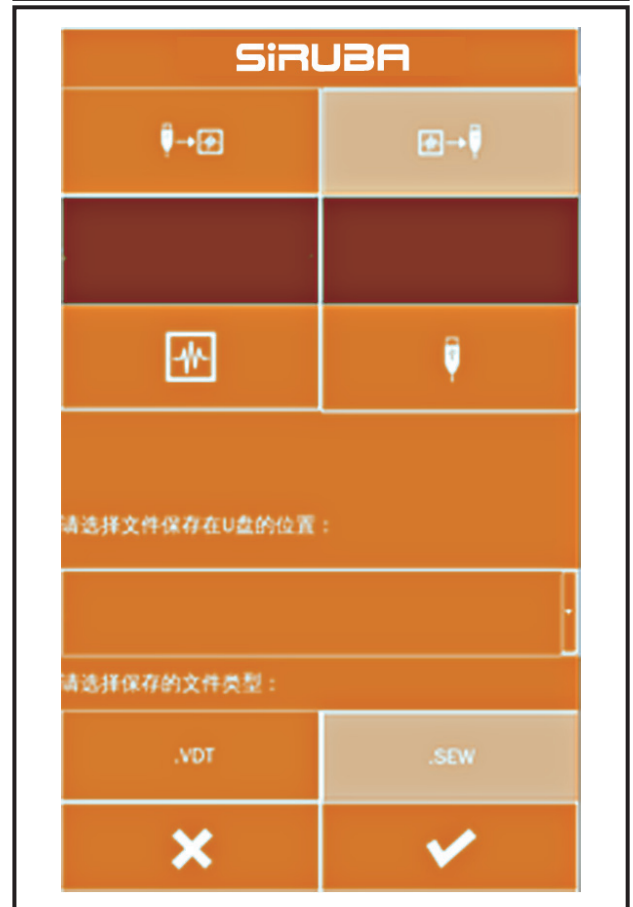

(2) 按操作盤按鈕 ，顯示出選擇操作盤檔介

面，如右圖所示。找到需要複製的檔，按確定

按鈕 。

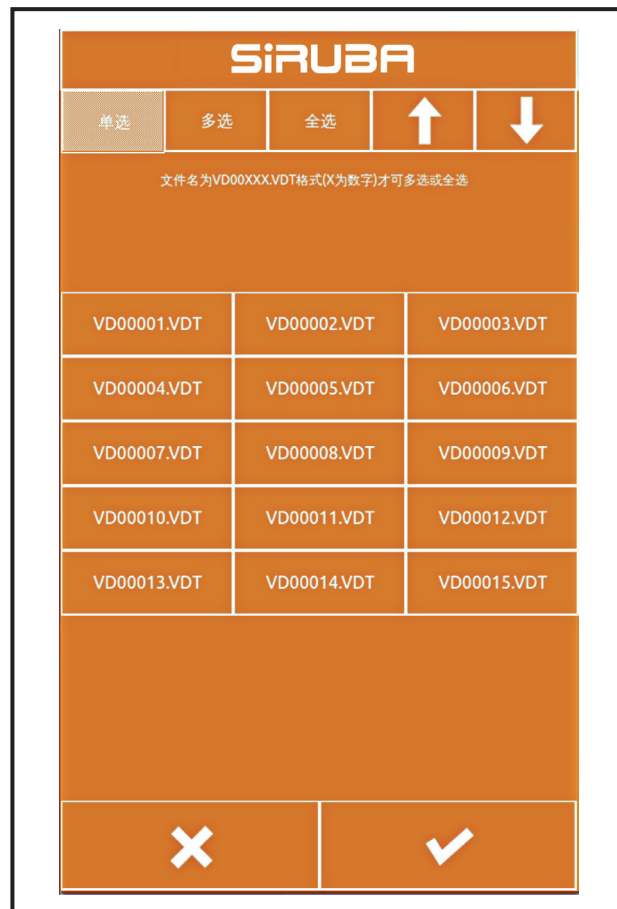

(3) 按 U 盤按鈕 ，顯示出輸入檔號介面，如

右圖所示。這個檔號是檔拷貝到 U 盤以後的檔

號，輸入檔號以後按確定按鈕 。



(4) 從操作盤選擇好檔並且輸入完 U 盤檔號以後，

如右圖所示，按確定按鈕 ，這樣就可以

將操作盤中的檔拷貝到 U 盤。

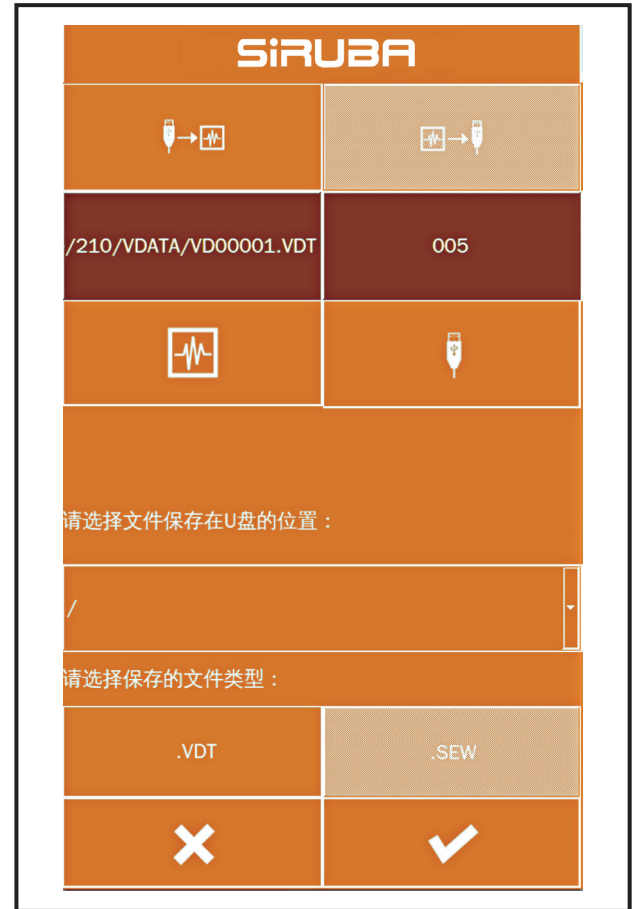

模式和參數設置

模式切換

普通縫製介面按下  可以進入設置介面（如右圖所示），在該介面下可以進行模式切換和設置。

三種模式：普通縫模式，花樣打版模式，迴圈縫模式。

普通縫模式

按普通縫鍵進入普通縫製介面，切換到普通縫模式。

花樣打版模式

按花樣打版鍵進入花樣打版介面，切換到打版模式，

在花樣打版介面可以自己畫圖、編輯花樣、修改花樣等。

迴圈縫模式

按迴圈縫鍵進入迴圈縫製介面，切換到迴圈模式。



測試

按測試鍵進入測試介面，如右圖所示。

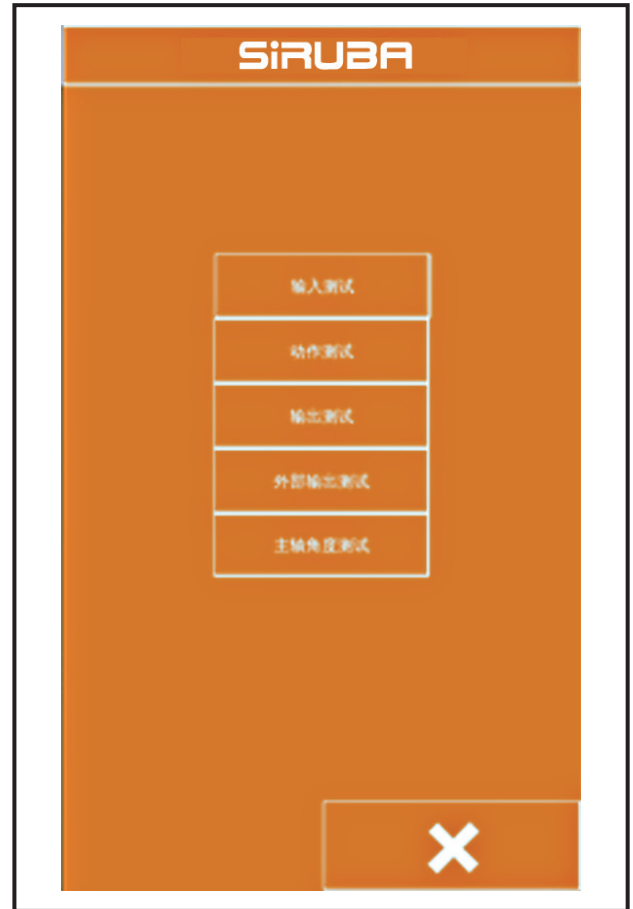

輸入測試

按輸入測試鍵進入輸入測試介面，如右圖所示，可以查看 X 原點，Y 原點，踏板開關，急停開關，斷線檢測的狀態。

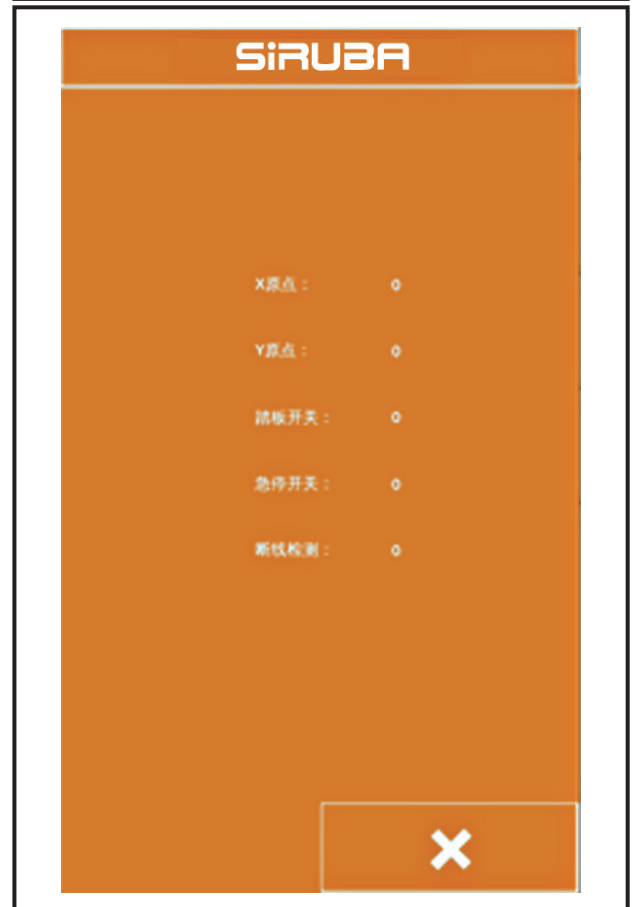

動作測試

按動作測試鍵進入動作測試介面，如右圖所示。可以測試 X 軸移動動作、Y 軸移動動作、剪線動作、中壓腳動作、穿線動作。

 : X 軸移動鍵

 : Y 軸移動鍵

 : 剪線鍵

 : 中壓腳鍵

 : 穿線鍵

選中需要測試的動作鍵，然後點加號鍵、減號鍵，如果對應機器部件有動作說明此動作能夠正常執行，按

 鍵關閉測試。

輸出測試

按輸出測試鍵進入輸出測試介面，如圖所示，選擇輸出口後，按加、減號鍵，如果對應輸出口的氣閥有動作，說明此輸出口可以正常工作，測試完成後按

 鍵關閉測試。

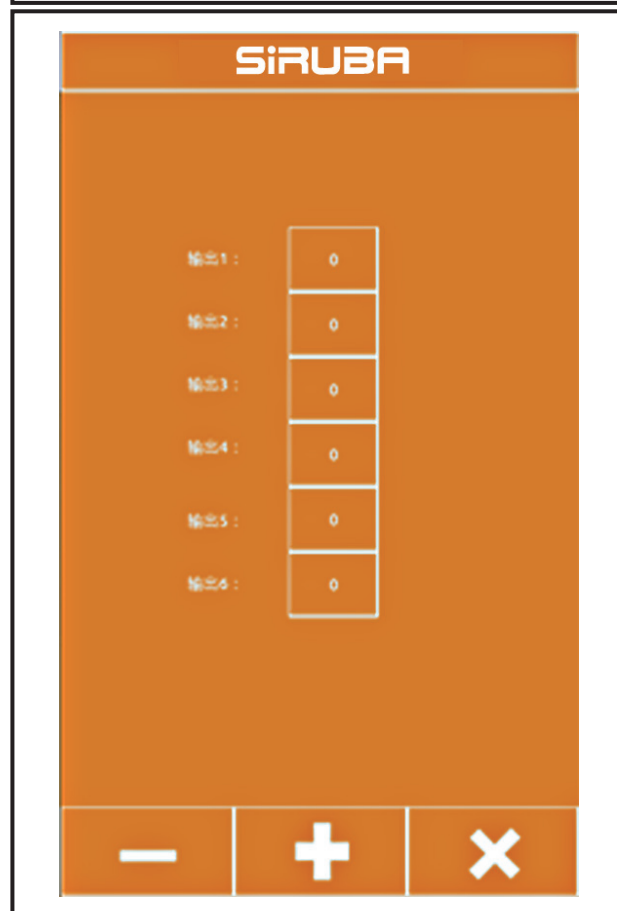
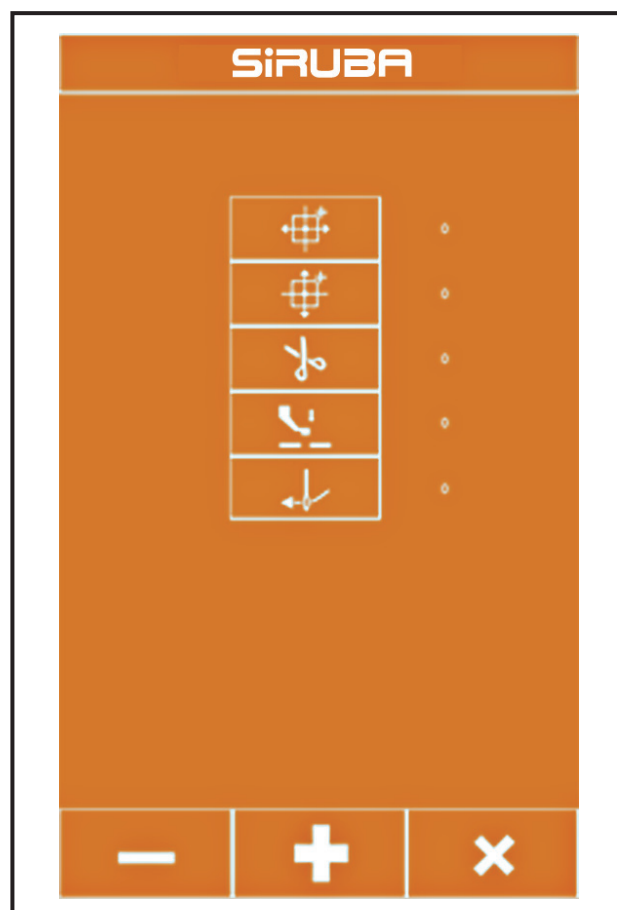

外部輸出測試

按外部輸出測試鍵進入外部輸出測試介面，如圖所示，

選擇外部輸出口後，按加、減號鍵，如果擴展板上對應的外部輸出口的氣閥有動作，說明此外部輸出口

可以正常工作，測試完成後按  鍵關閉測試。

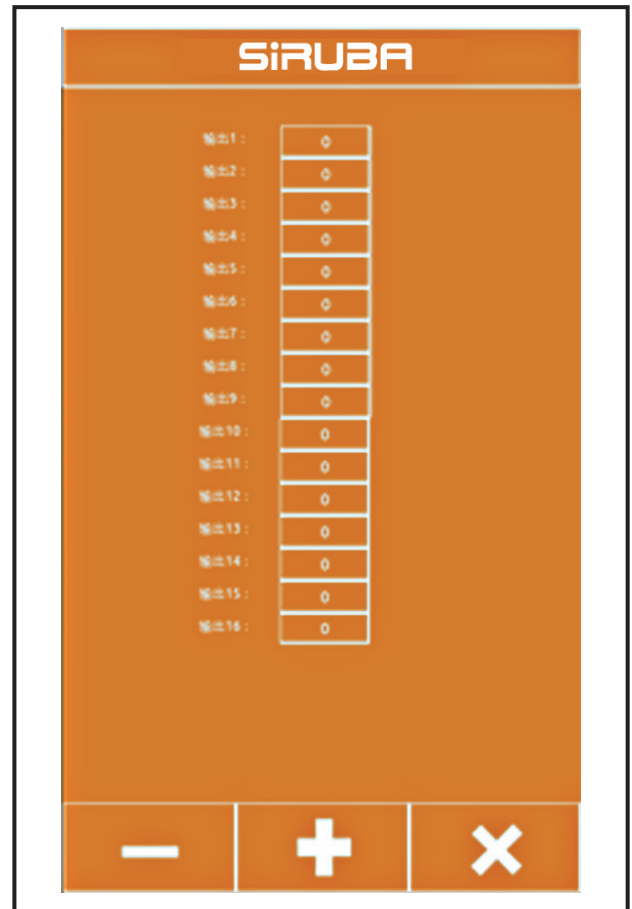

主軸角度測試

按主軸角度測試鍵進入主軸角度測試介面，如下圖所示，

可以查看當前的主軸角度，轉動機器的主軸，則

主軸角度會隨著轉動而變化。

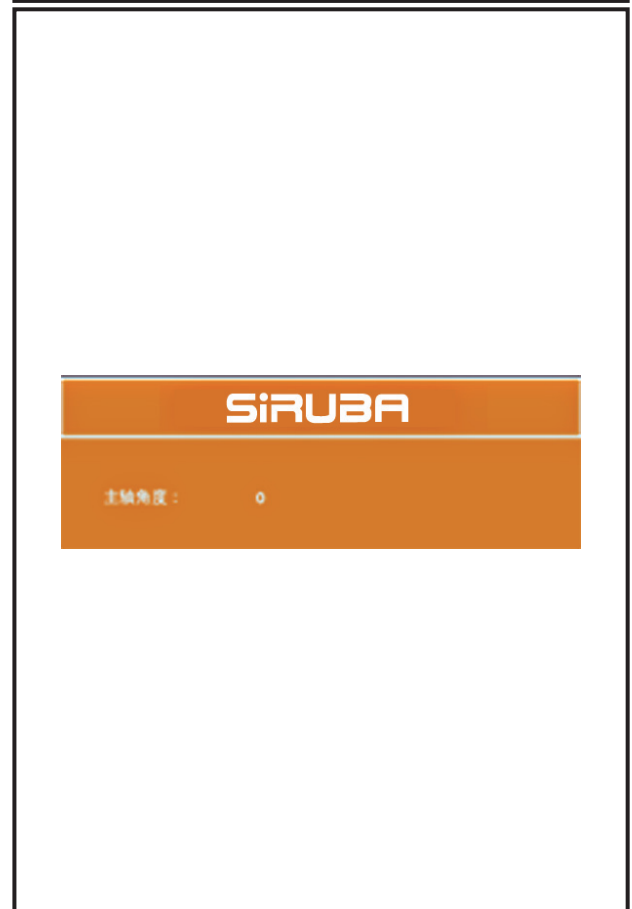

參數設置

點擊參數設置按鈕進入參數設置介面，如下圖所示。

參數設置主要功能是一些機器參數的設置和一些選項的設定。其中基本設置 1 中是一些比較常用的設置一般與控制板有關，基本設置 2 中的設置一般與控制板無關，只與面板有關，高級設置中是一些比較重要的設置，需要高級許可權的使用者通過輸入密碼才能進行設置，超級設置一般只有具有超級許可權的廠家技術人員才能進行設置。



The screenshot displays the SIRUBA parameter settings interface. At the top, the brand name "SIRUBA" is prominently displayed in white on an orange background. Below this, the interface is organized into four distinct sections, each with a title and a corresponding "进入" (Enter) button:

- 基本设置1:** The first section, labeled "基本设置1:", contains a single "进入" button.
- 基本设置2:** The second section, labeled "基本设置2:", also contains a single "进入" button.
- 高级设置:** The third section, labeled "高级设置:", includes a "密码:" label, a white text input field, and an "进入" button.
- 超级设置:** The fourth section, labeled "超级设置:", includes a "密码:" label, a white text input field, and an "进入" button.

At the bottom right of the interface, there is a large white "X" icon on an orange background, which likely serves as a close or exit button.

基本設置 1

點擊基本設置 1 中的進入按鈕，進入到常用基本參數

設置介面，如下圖所示，通過 、 鍵進行

前後翻頁，選中需要更改的參數按鈕，通過  鍵

可以查詢被選中參數的詳細資訊，然後通過 、

 鍵可以調整參數的值，設置好參數值以後點擊

 鍵，確保更改生效，點擊  鍵退出常用基

本參數設置介面。

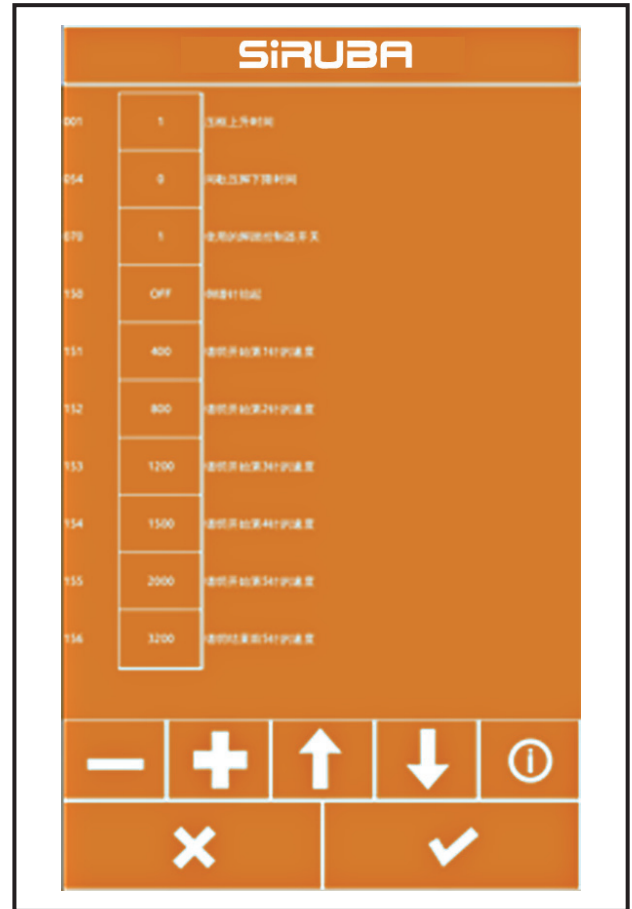

基本設置 1 參數說明如下表所示：

序號	設定範圍	初始值	設定單位	設定內容
1	OFF/1/2	1	-	壓框上升時間： 縫紉完成後壓框上升時間 OFF: 不自動上升 1: 在最後一針的位置上升 2: 移動到縫紉開始處後上升
54	0 ~ 2	0	1	間歇壓腳的下降時間： 0: 通過壓腳開關聯動下降，但在送布退避位置不下降 1: 通過壓腳開關聯動下降 2: 壓腳開關不聯動，縫製開始時下降
70	1 ~ 2	1	1	使用的腳踏控制器開關 1: 腳踏控制器開關 (單踏) 2: 雙連動腳踏控制器開關 (可選)
150	ON / OFF	OFF	-	倒縫針抬起 ON: 上軸停止時電機逆轉，針杆返回到最上方的位置 [注意] 抬起倒縫針時，由於挑線杆會停止在比平時低的位置，因此開始縫紉的時候，挑線杆要上升。所以，各別縫紉條件下會出現脫針的情況。 OFF: 無效

151	200 ~ 3200 (sti/min)	400	100	縫紉開始第 1 針的速度
152	200 ~ 3200 (sti/min)	800	100	縫紉開始第 2 針的速度
153	200 ~ 3200 (sti/min)	1200	100	縫紉開始第 3 針的速度
154	200 ~ 3200 (sti/min)	1500	100	縫紉開始第 4 針的速度
155	200 ~ 3200 (sti/min)	2000	100	縫紉開始第 5 針的速度
156	400 ~ 3200 (sti/min)	3200	100	縫紉結束前 5 針的速度
157	400 ~ 3200 (sti/min)	3200	100	縫紉結束前 4 針的速度
158	400 ~ 3200 (sti/min)	3200	100	縫紉結束前 3 針的速度
159	400 ~ 3200 (sti/min)	2400	100	縫紉結束前 2 針的速度
164	ON / OFF	OFF	-	禁止剪線動作 ON: 所有的剪線動作無效 OFF: 符合縫紉資料，進行剪線
462	0 ~ 2	0	1	擴大縮小的基準點 0: 縫紉邊框的中心 (原點) 1: 縫紉開始點 2: 圖案中心點
472	1 ~ 17	6	1	兩段壓腳設定： 設置二級壓腳的高度，單位為 mm。
500	ON/OFF	1	-	底線夾線功能設定 ON: 有效 OFF: 無效
566	ON/OFF	OFF	-	底線夾線裝置是否安裝 ON: 已安裝底線夾線裝置 OFF: 未安裝底線夾線裝置 [注意] 安裝底線夾線裝置時，請勿選擇 OFF。易造成裝置受損。
962	ON/OFF	OFF	-	斷線檢測 ON: 有效 OFF: 無效
964	ON/OFF	OFF	-	自動跑 ON: 有效 OFF: 無效
965	ON/OFF	OFF	-	手動夾線器起針打開 ON: 有效 OFF: 無效
966	0 ~ 2	2	1	撥線方式： 0: 無效 1: 電子式 2: 氣動式
992	0 ~ 1	0	1	移框方式 0: 縫製完成後移動到起縫點 1: 縫製完成後移動到指定點
1000	0 ~ 1	0	1	專用設備 0: 無效 1: 有效

基本設置 2

1. 基本設置 2 介面

點擊基本設置 2 中的進入按鈕，進入到基本設置 2 介面，如圖所示。

2. 基本設置 2 功能說明

(1) 恢復超級設置密碼

如果忘記了自己設置的超級密碼，可以使用恢復超級設置密碼為預設密碼。使用這個功能需要從我們這裡獲得密碼，從而獲得恢復許可權。

(2) 時間日期設置

設置當前的日期和時間。

(3) 上位機參數設置

按上位機參數設置鍵進入上位機參數設置介面，如下圖所示。

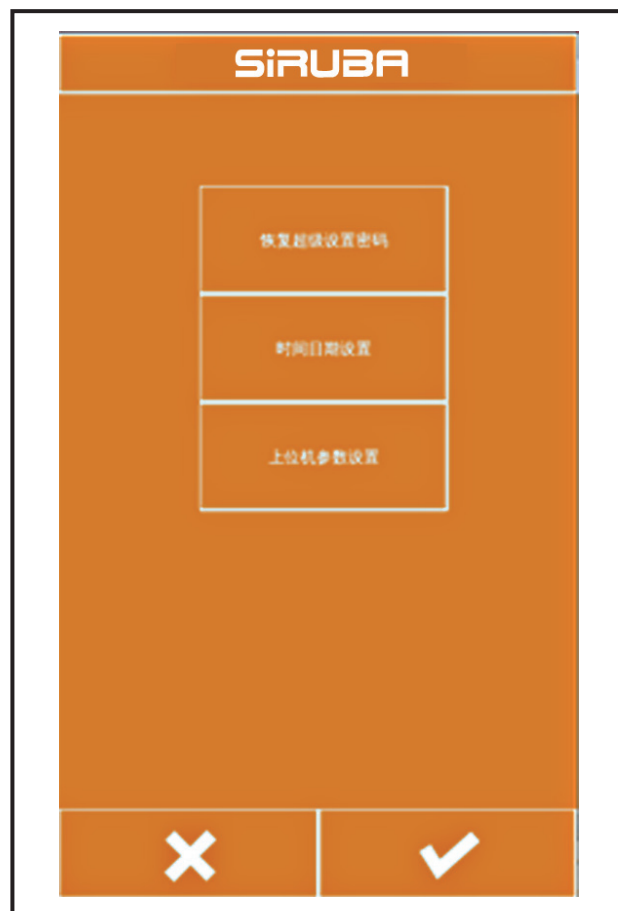

①提示音：ON：使用提示音，OFF：關閉提示音。

②提示音使用默認音：ON：提示音使用統一默認音，OFF：提示音不使用統一默認音。

③提示音類型：選擇默認提示音的類型。

④針跡顯示：ON：打版中所有狀態下都顯示針跡點；OFF：打版中在對針跡點操作時才顯示針跡點。

⑤動力類型：根據機器動力類型選擇氣動或者電動。

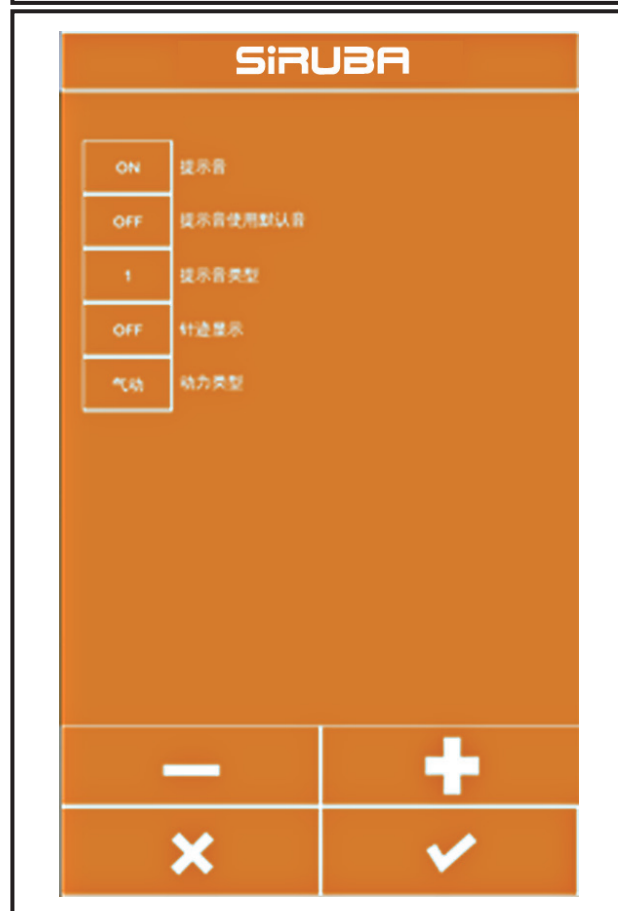

高級設置

高級設置介面

點擊密碼後面的空白處可以輸入密碼，輸入密碼後，點擊進入按鈕，進入到高級設置介面，如下圖所示，其中密碼設置按鈕可以更改進入高級設置的密碼，參數設置按鈕可以設置一些高級參數，上位機升級按鈕可以對面板程式進行升級，下位機升級按鈕可以對控制板程式進行升級，恢復出廠設置按鈕可以將程式的一些參數恢復到出廠時的設置，原點調整按鈕可以對原點位置進行調整。



高級設置參數

點擊參數設置按鈕，可以進入高級參數設置介面，如圖所示。

- (1) 語言選擇：設置中英文。
- (2) 範本機狀態：OFF：不使用範本自動感應功能；
ON：使用範本自動感應功能。
- (3) 範本檢測：預設設置為 OFF，如果設置為 ON，
範本離開範本感應器機器會報錯。
- (4) 範本位置感測器：預設設置為 OFF，如果設置為
ON，範本離開範本感應器機器不工作。
- (5) 機頭記憶體：有機頭記憶體需要設置為 ON。
- (6) 剪線角度調整：負值提前，正值是延時（-60
到 30）。
- (7) 送布時間調整：負值提前，正值是延時（-60
到 30）。
- (8) 斷線檢測針數：設置斷線檢測針數靈敏度。
- (9) 空送速度：設置空送速度等級（1-10），數值
越大越快。
- (10) 停針角度調整：設置主軸停止角度。

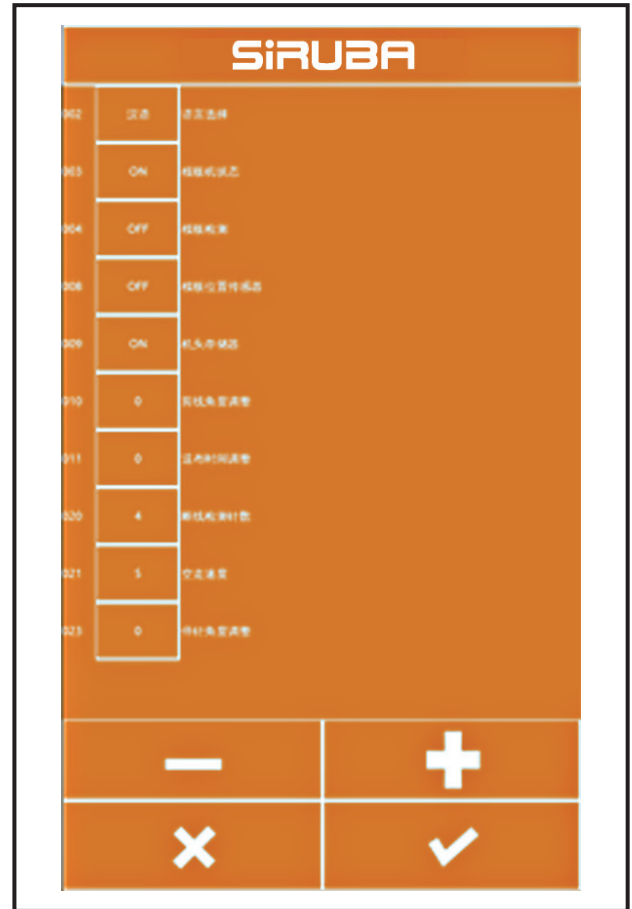

上位機升級

本程式可以通過 U 盤對上位機（面板）進行升級，升級前需要將新版本程式 panel 檔和 qm 資料夾一起複製到 U 盤主目錄，然後將 U 盤插入面板，然後通過參數設置 ---> 高級設置 ---> 上位機升級對面板程式進行升級，升級成功後會出現“成功，請重啟”提示，重啟即可。

8.3.3.4 下位機升級

本程式可以通過 U 盤對下位機（控制板）進行升級，升級前需要將新版本程式 nc.bin 檔複製到 U 盤主目錄，然後將 U 盤插入面板，然後通過參數設置 ---> 高級設置 ---> 下位機升級對控制板程式進行升級，升級成功後會出現“成功，請重啟”的提示，重啟即可。

超級設置

超級設置介面

超級設置介面如圖所示，由廠家進行設置，用戶不能隨意更改。一般出廠前需要對超級設置中的參數進行設置。



超級設置參數

點擊參數設置按鈕，進入超級參數的參數設置介面，如圖所示。

- (1) 機器類型：根據機器類型選擇相應的型號。
- (2) 顯示風格：一般選擇默認風格即可。
- (3) 縫紉速度限制值：設置縫紉速度最大值，設置好以後縫紉速度不會超過這個值。



分期付款設置

按分期付款鍵進入分期付款介面，進入分期付款介面需要輸入密碼才能進行下一步設置，獲取此密碼請聯繫廠家，輸入密碼後可以設置面板 ID 號，設置好 ID 號以後機器就不能縫製了，需要在高級設置中輸入分期付款密碼才能進行縫製。獲取分期付款密碼請聯繫廠家。

協助工具

按協助工具鍵進入協助工具介面，如圖所示。



範本 ID

這個功能是用來定義範本的，範本上個有無線識別卡。每一個卡都有一個 ID 號，這個 ID 號與面板中的 P 花樣號對應。當新做了一塊無線識別卡範本或者更改範本 ID 時，將無線識別卡放到範本感應器上，然後在協助工具介面的範本 ID 編輯方塊中輸入範本 ID 號，輸入完成後點擊“寫入”按鈕，即可將範本 ID 號寫入無線識別卡，寫入完成會提示成功。

更改啟動圖片

如果想更改面板啟動時候顯示的圖片，可以將需要顯示的圖片發給我們，然後我們將圖片更改為指定格式的檔再發送給您，您將這個修改後的圖片檔放到 U 盤中，將 U 盤插到面板上，就可以點擊“更改”按鈕更改啟動圖片，更改完成會提示成功。

內核升級

當需要對內核進行升級的時候，我們會提供 conprog.bin 檔給您，您將這個檔放入 U 盤，將 U 盤插到面板上，待面板識別 U 盤完成後，就可以點擊“內核升級”按鈕進行升級，升級完成後會提示升級成功。

提示音升級

當需要對按鍵提示音進行升級的時候，我們會提供 wxaudio 資料夾給您，您將這個資料夾放入 U 盤，將 U 盤插到面板上，待面板識別 U 盤完成後，就可以點擊“提示音升級”按鈕進行升級，升級完成後會提示升級成功。

計數器

按計數器鍵進入計數器介面，如右圖所示。可以設置縫製計數器和針數計數器的模式，可以設置計數器當前值和最大值。

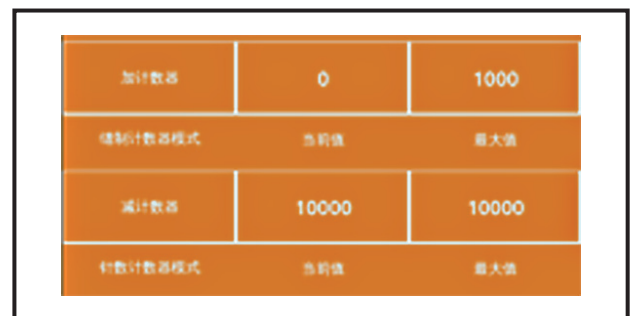

關於

按關於鍵進入版權資訊查詢介面，輸入密碼可以查看版權資訊。

附錄 1 誤碼表

萬一機器發生故障時，操作面板會顯示錯誤代碼。

請按照下表的處理方法來排除故障。

錯誤代碼	描述
10	摠了緊急停止開關。摠 RESET 鍵，消除錯誤。
11	摠暫停開關。摠 RESET 鍵，消除錯誤。摠該鍵後移動壓腳，可以繼續縫紉。
12	摠暫停開關。摠 RESET 鍵消除錯誤後，將腳踏板踩到第 2 檔，進行原點檢驗。
15	電源接入時摠了緊急停止開關，但是緊急停止開關接觸不良。切斷電源，確認主機板插座 P9 的插頭。
16	電源接入時緊急停止開關接觸不良。切斷電源，確認主機板插座 P9 的插頭。
25	電源接入時，腳踏板開關被踩到第 2 檔的位置。（2 腳踏板開關時，是起動開關）切斷電源，確認腳踏板開關。
35	電源接入時腳踏板開關被踩到第 1 檔的位置。（2 腳踏板開關時，是壓緊開關）切斷電源，確認腳踏板開關。
50	電源接入後，發現縫紉機頭傾倒。切斷電源，扶起縫紉機頭。確認主機板插座 P14 的插頭。
51	縫紉機啟動過程中發現縫紉機頭傾倒。切斷電源，確認主機板插座 P14 的插頭。
55	電源接入時，發現縫紉機頭傾倒。切斷電源，扶起縫紉機頭。切斷電源，確認主機板插座 P14 的插頭。
65	電源接入時，操作面板的鍵是摠下的狀態，或者鍵的接觸不良。切斷電源，確認操作面板鍵。
100	“GREASEUP”通知出現後，若不添加潤滑脂（不進行清除工作的操作）。添加潤滑，然後執行清除工作的操作。
111	停車位置不正確 --- 切斷電源，確認剪線裝置或者縫紉機電機是否出現異常現象。
121	剪線無法完成。切斷電源，確認固定刀、移動刀的刀刃部分是否出現刮痕或受損。
130	主馬達故障 --- 主軸電機故障，或主軸電機控制器故障。
131	同步顯示器接觸不良。切斷電源，確認電機主機板插盤 P11 的插頭狀況是否良好。
132	發現縫紉機主馬達非正常旋轉切斷電源，確認電機主機板插盤 P11 的插頭狀況是否良好。
133	縫紉主馬達停止位置不良。切斷電源，確認電機主機板插盤 P11 的插頭狀況是否良好。
150	縫紉機主馬達非正常升溫或者溫度感測器運轉不良。切斷電源，確認縫紉機電機狀況。（如果反復進行短運針數（15 針一下）的縫紉資料縫紉（短週期），上軸電機過熱，就有發生 [E150] 故障的可能。）
200	X 方向找不到原點 ---X 電機故障，或 Y 原點感測器故障
201	X 脈衝馬達非正常停止。切斷電源，確認 X 送布方向是否存在異常現象。
203	X 電機過電流 ---X 電機故障，或 X 電機控制板故障
204	縫紉過程中，X 脈衝馬達非正常停止。切斷電源，確認 X 送布方向是否存在異常現象。
205	向縫紉開始位置移動過程中，X 脈衝馬達非正常停止。切斷電源，確認 X 送布方向是否存在異常現象。
206	檢驗傳送過程中，X 脈衝馬達非正常停止。切斷電源，確認 X 送布方向是否存在異常現象。
207	無法檢測到 X 電機運動 ---Y 電機故障，或 X 電機編碼器故障，或 X 電機控制板故障
208	X 電機失控 ---X 電機編碼器故障，或 X 電機控制板故障
210	Y 方向找不到原點 ---Y 電機故障，或 Y 原點感測器故障
211	Y 脈衝馬達非正常停止。切斷電源，確認 Y 送布方向是否存在異常現象。

213	Y 電機過電流 ---Y 電機故障，或 Y 電機控制板故障
214	縫紉過程中，Y 脈衝馬達非正常停止。切斷電源，確認 Y 送布方向是否存在異常現象。
215	向縫紉開始位置移動過程中，Y 脈衝馬達非正常停止。切斷電源，確認 Y 送布方向是否存在異常現象。
216	檢驗傳送過程中，Y 脈衝馬達非正常停止。切斷電源，確認 Y 送布方向是否存在異常現象。
217	無法檢測到 Y 電機運動 ---Y 電機故障，或 Y 電機編碼器故障，或 Y 電機控制板故障
218	Y 電機失控 ---Y 電機編碼器故障，或 Y 電機控制板故障
300	剪線電機找不到原點 --- 剪線電機故障，或剪線電機編碼器故障
301	無法檢測壓腳／鈕扣夾的上升、下降。切斷電源，確認壓腳／鈕扣夾的上下方向是否存在異常現象。
303	剪線電機過電流 --- 剪線電機故障，或剪線電機控制板故障
307	無法檢測到剪線電機電運動 --- 剪線電機故障，或剪線電機編碼器故障，或剪線電機控制板故障
308	剪線電機失控 --- 剪線電機編碼器故障，或剪線電機控制板故障
320	抓線電機找不到原點 --- 抓線電機故障，或抓線電機編碼器故障
321	抓線電機過電流 --- 抓線電機故障，或抓線電機控制板故障
323	無法檢測到抓線電機電運動 --- 抓線電機故障，或抓線電機編碼器故障，或抓線電機控制板故障
324	抓線電機失控 --- 抓線電機編碼器故障，或抓線電機控制板故障
400	電源接入時，檢測出主機板和控電板主機板之間的連結通信錯誤。切斷電源，確認控電板主機板的插座 P1 和電機主機板的插座 P3 的插頭狀況是否良好。
401	電源接入時，檢測出主機板和電機主機板之間的連結通信錯誤。切斷電源，確認主機板的插座 P5 和電機主機板的插座 P2 的插頭狀況是否良好。
410	檢測出主機板和控電板主機板之間的通信錯誤。切斷電源，再次接入電源。
411	檢測出主機板和電機主機板之間存在通信錯誤。切斷電源，再次接入電源。
420	未插入存儲工具。摁 RESET 鍵，排除錯誤。
421	由於資料內容不正確無法使用，或者無數據。摁 RESET 鍵，排除錯誤。確認存儲工具中是否存入該式樣序號的資料。
422	讀取存儲工具資訊時發生錯誤。摁 RESET 鍵，排除錯誤。確認存儲工具內的資料。
424	存儲工具內空間不足。摁 RESET 鍵，排除錯誤。使用其他存儲工具。
425	寫入存儲工具時發生錯誤。摁 RESET 鍵，排除錯誤。請使用指定存儲工具。確認是否是禁止寫入，或者是否有空間。
427	註冊在迴圈程式中的式樣被刪除。摁 RESET 鍵，排除錯誤。重新註冊迴圈程式，添加式樣。
428	設定在程式中的式樣被刪除。摁 RESET 鍵，排除錯誤。重新設定程式，添加花樣。
430	資料無法備份到主機板。切斷電源，並重新接入電源。
440	主機板資料存儲異常。切斷電源，並重新接入電源。
450	無法從機頭部存放裝置讀取機種選擇資訊。切斷電源，確認電源電機主機板的插排 P16 的插頭狀況是否良好。
451	不能將資料存儲到機頭記憶體中。切斷電源，並重新接入電源。
452	無法連接到機頭部存放裝置。切斷電源，確認主機板的插排 P16 的插頭狀況是否良好。
480	範本位置感應器異常
500	做擴大設定之後，縫紉資料超過可以縫紉的區域。摁 RESET 鍵，排除錯誤。再次設定擴大倍率或者縫紉區域。
502	做擴大設定之後，資料螺距超過最大螺距 12.7mm。摁 RESET 鍵，排除錯誤。再次設定擴大倍率。

510	程式資料出現異常。摠 RESET 鍵，排除錯誤。從存儲工具中重新讀取程式資料，或者重新輸程式資料。
511	完成代碼無法輸入到程式資料中。摠 RESET 鍵，排除錯誤。重做輸入完成代碼的程式資料，或者變更讀取程式的序號。
512	超過可以使用的針數。摠 RESET 鍵，排除錯誤。變更讀取程式的序號。
581	無法正確讀取存儲開關資料夾。複製前機種和複製後機種不正確。(438F 的資料有讀取到 430F 的可能性) 摠 RESET 鍵，排除錯誤。請讀取同一機種的資料。
582	存儲開關的版本不一致。摠 RESET 鍵，排除錯誤。請讀取同一版本的資料。
583	參數的版本不一致。摠 RESET 鍵，排除錯誤。請讀取同一版本的資料。
600	發生麵線斷裂。摠 RESET 鍵，排除錯誤。摠 KEY_STEP_BACK 鍵後移動壓腳，可以繼續縫紉。
690	中壓腳電機找不到原點 --- 中壓腳電機故障，或中壓腳電機編碼器故障
691	底線夾線馬達非正常停止。確認是否麵線餘量過長。切斷電源，清除針板底部的飛絨。確認主機板基板的插座 P20、P4 的插頭狀況是否良好。
693	中壓腳電機過電流 --- 中壓腳電機故障，或中壓腳電機控制板故障
697	無法檢測到中壓腳電機電運動 --- 中壓腳電機故障，或中壓腳電機編碼器故障，或中壓腳電機控制板故障
698	中壓腳電機失控 --- 中壓腳電機編碼器故障，或中壓腳電機控制板故障
700	電源電壓異常上升。切斷電源，確認輸入電壓。
701	縫紉機主馬達驅動電壓異常上升。切斷電源，確認電壓
705	電源電壓異常下降。切斷電源，確認輸入電壓。
710	縫紉主馬達檢出異常電流。切斷電源，確認縫紉機是否出現異常。
711	脈衝電機檢出異常電流。切斷電源，確認壓腳 / 鈕扣夾的運轉是否出現異常。
720	機頭無法下降
721	機頭無法上升
820	花樣佇列空
821	花樣無結束碼
822	花樣無停車碼
830	花樣數據溢出
850	CAN 匯流排應答錯誤
901	X 電機脈衝錯誤 (內部錯誤)
902	Y 電機脈衝錯誤 (內部錯誤)
903	剪線電機脈衝錯誤 (內部錯誤)
904	中壓腳電機脈衝錯誤 (內部錯誤)
905	抓線電機脈衝錯誤 (內部錯誤)
906	內部錯誤
911	內部錯誤
912	內部錯誤
913	內部錯誤
914	內部錯誤



高林股份有限公司
KAULIN MFG. CO., LTD.

由於對產品的改良及更新，本產品使用說明書中與零件圖之產品及外觀的修改恕不事先通知！
The specification and/or appearances of the equipment described in this instruction book & parts list are subject to change because of modification which will without previous notice.
PATTERN MACHINE TOUCH PANEL. OCT. 2018